



347V DALI Dimming LED Driver

- 1050mA Constant Current Output
- Class 2, 55W Output
- DALI Dimming to 1%

Performance

Input Voltage	347 Vac
Input Current Max	0.185/347V
Input Power Max	63W
Input Frequency	50 - 60 (Hz)
Power Factor	> 0.95
THD max	< 20 %
Output Voltage	15-53V
Output Current	11mA - 1050mA
Output Power	55W
Line Regulation	±3 %
Load Regulation	±5 %
Output Current Ripple	<10% (Pk-Pk/avg)
Inrush Current Peak / >50% Duration	347V: 2.7A / 175uS

- Inrush current complies with NEMA 410
 * Refer to charts for additional information

Environmental

EMI and RFI	Meets FCC part 15 (Class A) Non-Consumer Limits
Min. Operating Temperature	-40°C (-40°F)
Storage Temperature	-40°C to 85°C (-40°F to 185°F)
tc	85°C (185°F) max
Protection Rating	UL Dry & Damp
Transient Protection	IEEE C62.41 2.5kV/2.5kV

Physical

Length	4.93 in (125 mm)
Width	2.95 in (75 mm)
Height	1.00 in (25.4 mm)
Mounting Length	4.59 in (116.6 mm)
Weight (lbs)	1.0
Wire Trap / Plug-in Connectors for 18 AWG Solid Wire	

Protection

Over voltage, Under voltage, short circuit, and over temp.

Safety:

UL 8750 & CSA 250.13
 Class P

DALI Control

Compatible DALI protocol: IEC 62386
 Control circuit listed for Class 1 or Class 2 wiring
 Apply DALI control circuit to connectors marked DA

Ordering Information

Order Number	Description	Qty/Carton
D10CC55347D-K010C	Multi-Exit	20
D10CC55347D-KS10C	Bottom Exit w/ Studs	20

Wiring Diagram:

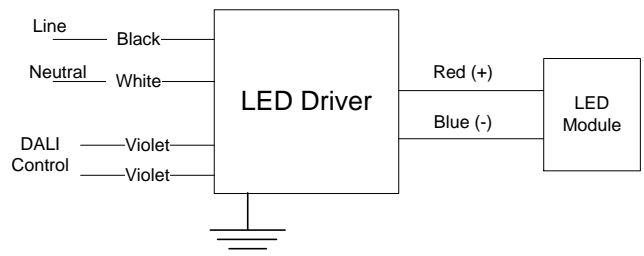

Application and operation performance specification information subject to change without notification.

Performance: Efficiency, THD, & Power Factor

Typical performance measurements are shown. The charts are to be used as a guideline and not for specification use.

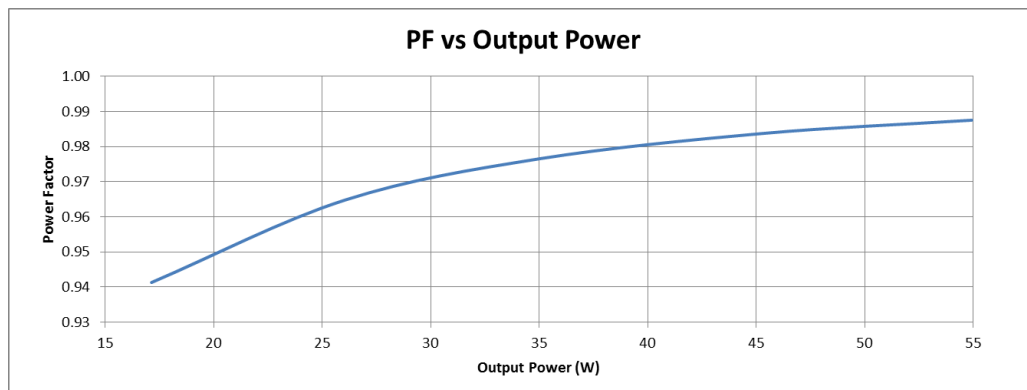
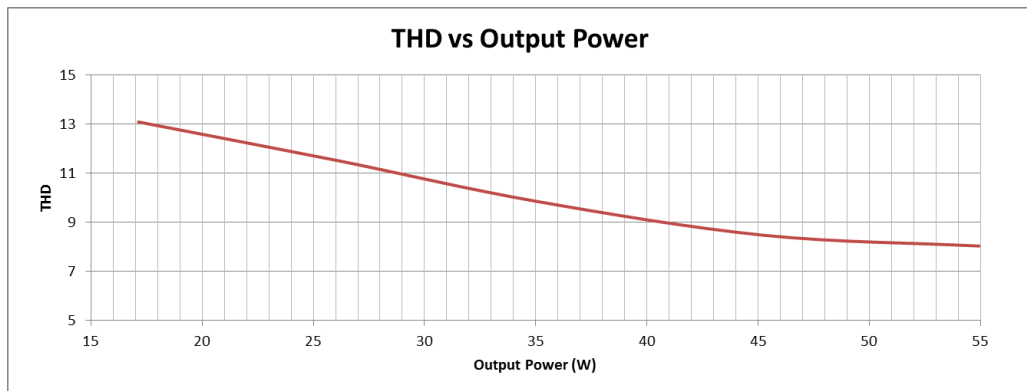
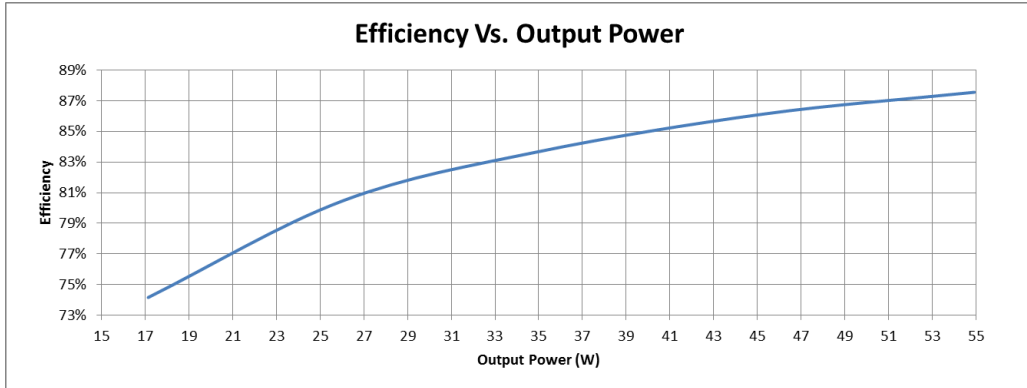

Output power based on maximum rated output current and varying load voltages.

Application and operation performance specification information subject to change without notification.

DALI Dimming

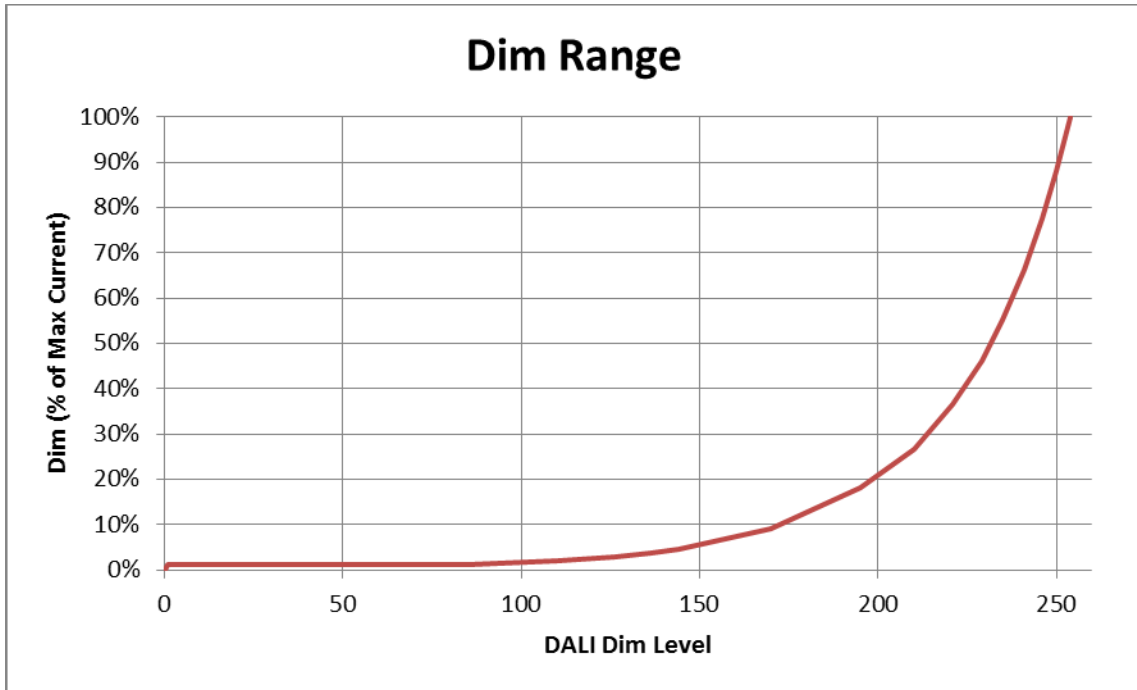

DALI Control

Compatible DALI protocol: IEC 62386
 Control circuit listed for Class 1 or Class 2 wiring
 Apply DALI control circuit to connectors marked DA

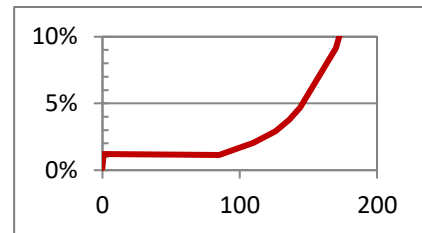

DALI Tuning

- Programmable output tuning can be performed using DALI commands that are part of the DALI standard.
- Tuned levels are based on a percentage of the maximum rated output current.
- See App Note EVD08 at <http://unvlt.com/products/drivers/application-notes/>

Application and operation performance specification information subject to change without notification.

Dimensions

-K

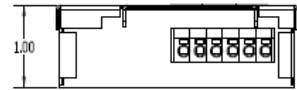
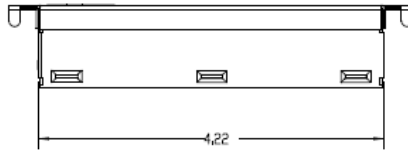
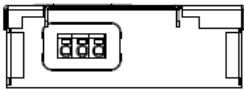
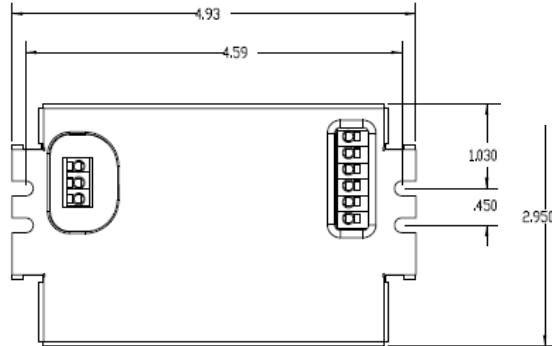

-KS

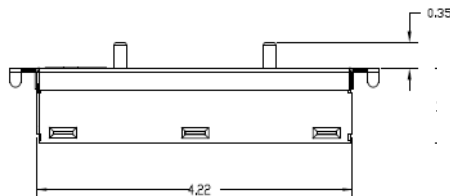
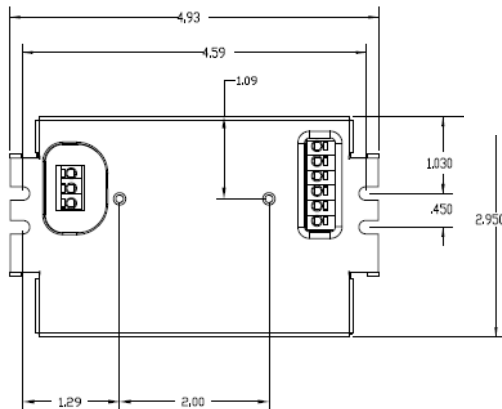

KS Provides lead exits at the bottom only

Application and operation performance specification information subject to change without notification.

Life vs. Driver Tcase

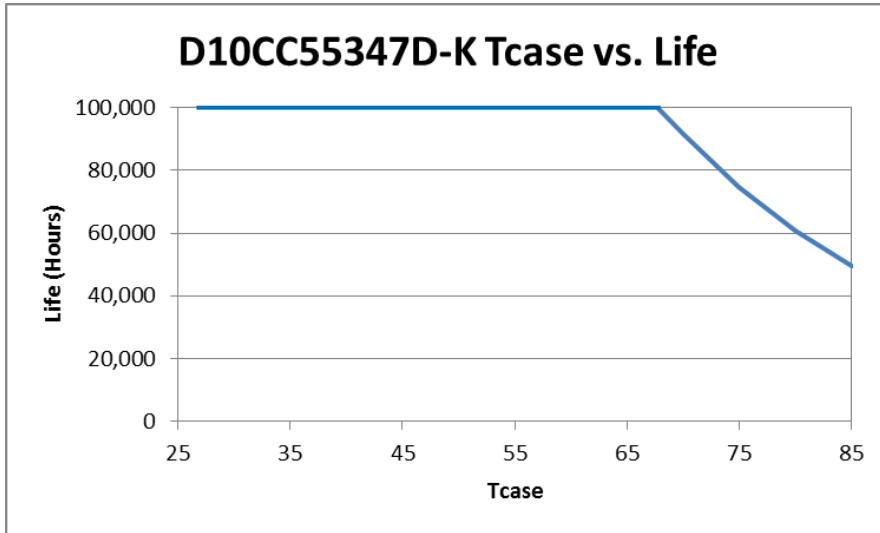

The Data curve provided predicts the LED Driver life based on the case temperature measured at the Tc location identified on the label or specification sheet. The Telecordia SR-332 standard is used to generate the prediction curves.

Tc Location:

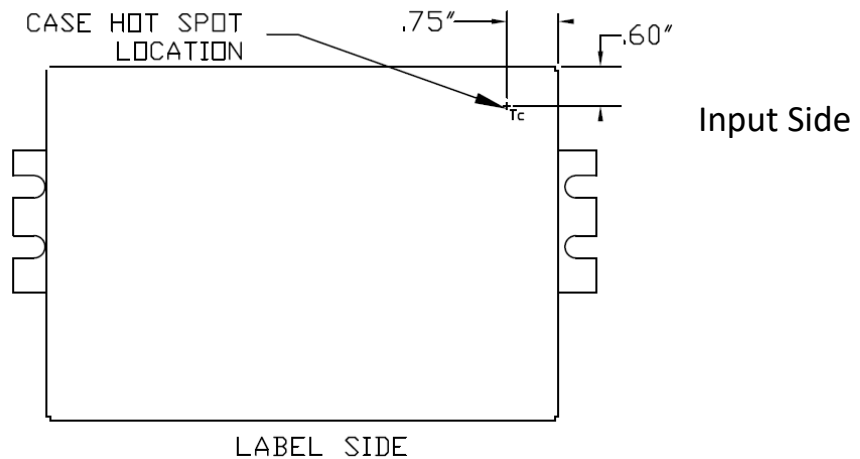

Application and operation performance specification information subject to change without notification.

FCC Statement: This device complies with part 15 of the FCC Rules. Operation is subject to the following two conditions: (1) This device may not cause harmful interference, and (2) this device must accept any interference received, including interference that may cause undesired operation.

Warranty:

Universal Lighting Technologies warrants to the purchaser that each power supply will be free from defects in material or workmanship for a period of 5 years from the date of manufacture when properly installed per instructions and under normal operating conditions of use. Call 1-800-225-5278 for technical assistance.

Application and operation performance specification information subject to change without notification.