

1100mA Selectable Output Current LED Driver

- 1100/1050/1000/950mA Selectable Output Current
- 0-10V dimming to 5% with dim-to-off
- Class B EMI at 120Vac input



Performance	
Input Voltage	120 ~ 277 Vac
Input Current Max	0.55 / 120V 0.25 / 277V
Input Power Max	66.2W
Input Frequency	50 - 60 (Hz)
Power Factor	> 0.95 @ max load
THD max	< 20 % @ max load
Output Voltage	35V to 52V
Max. Output Current	950/1000/1050/1100mA
Min. Dimming Current	5% of selected Iout
Max. Output Power	57.2W
Standby Power	< 0.25W @120Vac < 0.75W @ 277Vac
Line Regulation	±5 %
Load Regulation	±5 %
Output Current Ripple	<30% (Pk-Pk/avg)
Inrush Current*	120V: 34A / 100uS 277V: 19A / 120uS
LED Start Up Time	<500mS

* Source impedance per NEMA 410

Environmental	
EMI and RFI	FCC part 15 (Class B) at 120V FCC part 15 (Class A) at 277V
Operating Temp.	-40°C to 40°C / -40°F to 104°F
Storage Temperature	-40°C to 85°C / -40°F to 185°F
tc	75°C max for warranty 90°C max for UL
Protection Rating	UL Dry & Damp
Transient Protection	IEEE C62.41 2.5kV

Physical	
Length	6.10 in (155 mm)
Width	1.69 in (43 mm)
Height	1.00 in (25.5 mm)
Mounting Length	5.71 in (145 mm) w/ 1.22 in (31 mm) offset
Weight (lbs)	0.5 lbs
Lead Lengths	
Blk, Wht 18AWG / 105°C / 600V	5.90 in (150 mm)
Red(LED+), Blue(LED-) 18AWG / 105°C / 300V	5.90 in (150 mm)
Vio(Dim+), Pink*(Dim-) 20AWG / 105°C / 300V	12.40 in (315 mm)

Protection

Over Voltage, Short Circuit, Over Temp

Safety:

UL 8750 & CSA 250.13

UL Class P



Ordering Information

Order Number	Description	Qty/Carton
D11CC57UNVSL-GC030C	1100mA 57W	30

Wiring Diagram:

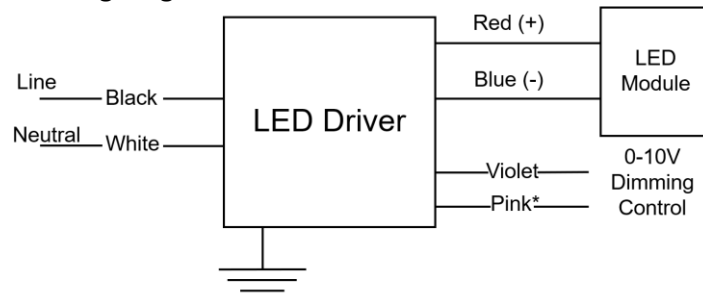

* **Note:** The Gray has been changed to Pink for the negative 0-10V dimming control lead.

Application and operation performance specification information subject to change without notification.

Selectable Output Current

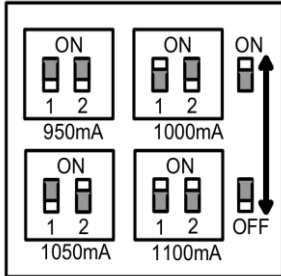

Switch 1	Switch 2	Output Current
On	On	1100mA (default)
Off	On	1050mA
On	Off	1000mA
Off	Off	950mA

0-10V Dimming

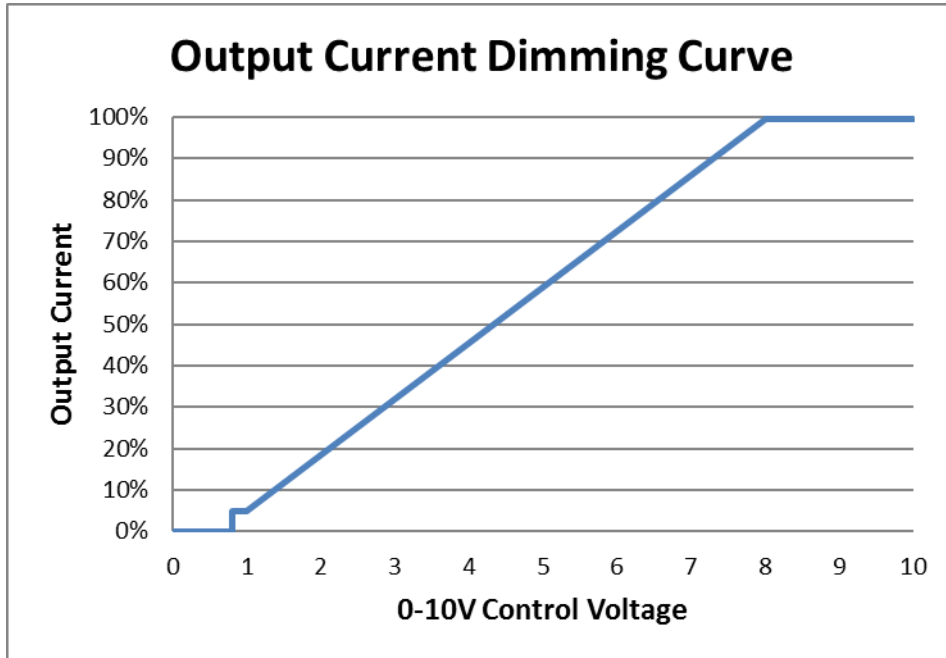

Control Voltage	Light Output
8V	100%
1V	5%
0.8V	Turn-Off
1V	Turn-On

0-10V Analog Dimming Interface

- Analog 0 to 10 vDC Voltage Control
- Use Violet (+) & Pink* (-) for connection to 0-10vDC.
- 10v = maximum output, 0v = dim-to-off
- Wiring Violet & Pink* together provides min. light output.
- Capping Violet & Pink* separately provides 100% light output.
- 0-10V interface can be wired as a Class 1 or Class 2 Circuit.
- Driver will source a maximum of 165uA for control needs.
- Controller must sink current from the 0-10V control leads.

Application and operation performance specification information subject to change without notification.

Performance: Efficiency

Typical performance measurements are shown. The charts are to be used as a guideline and not for specification use.

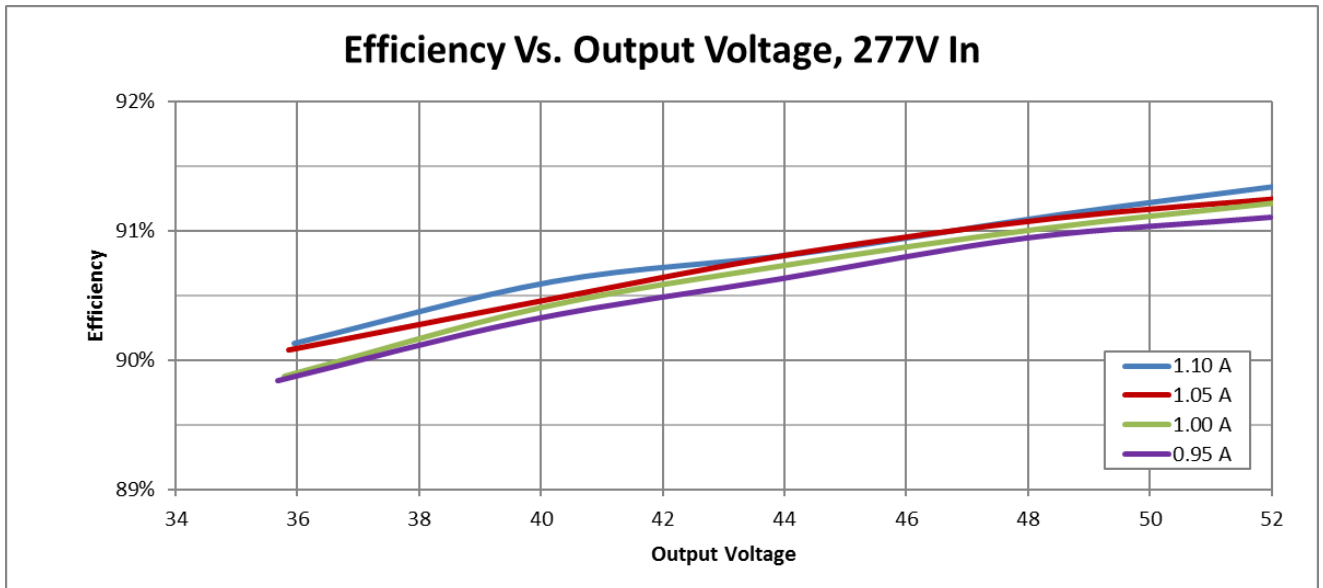
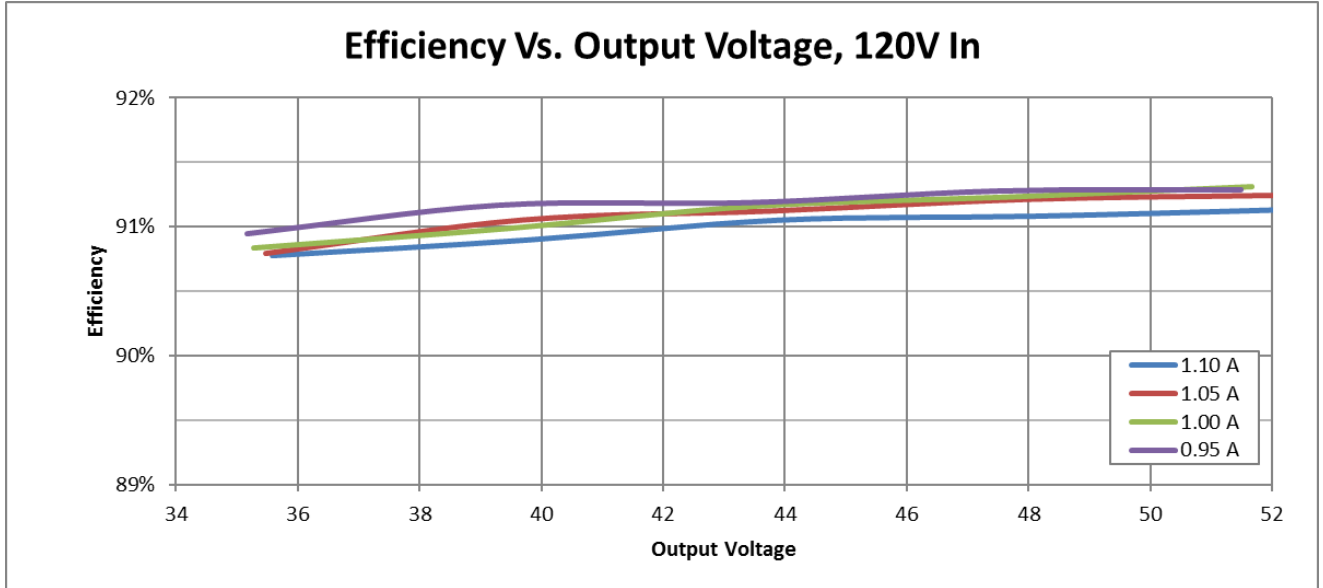

Application and operation performance specification information subject to change without notification.

Performance: Total Harmonic Distortion, & Power Factor

Typical performance measurements are shown. The charts are to be used as a guideline and not for specification use.

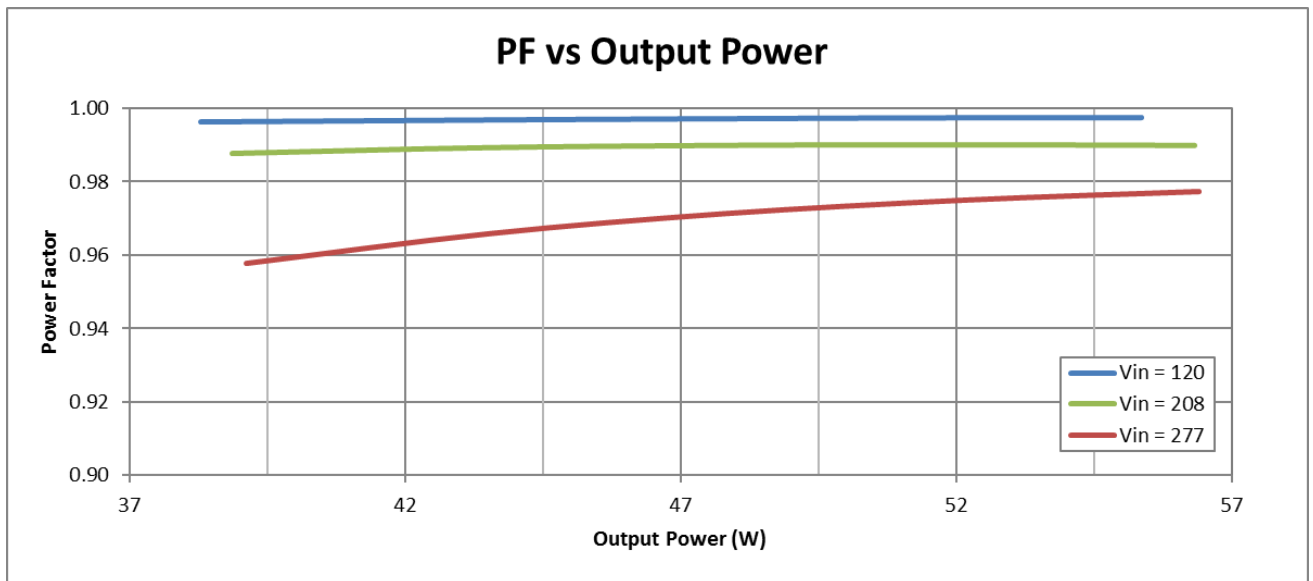
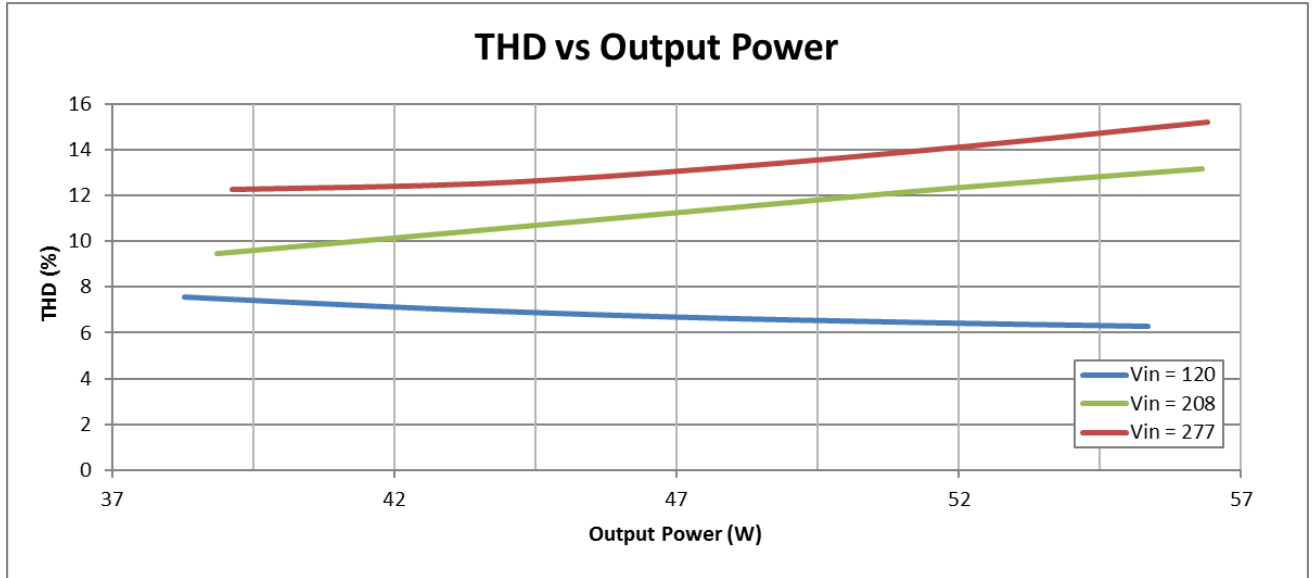

Output power based on maximum rated output current and varying load voltages.

Application and operation performance specification information subject to change without notification.

Transient Protection	
Transient	Differential Mode (L-N)
IEEE C62.41 100kHz Ring Wave (200A maximum)	> 2.5kV

Isolation				
Isolation	Input	Output	0-10V	Enclosure
Input	-	2xU + 1kV	2xU + 1kV	2xU + 1kV
Output	2xU + 1kV	-	2xU + 1kV	700V
0-10V	2xU + 1kV	2xU + 1kV	-	2xU + 1kV
Enclosure	2xU + 1kV	700V	2xU + 1kV	-

U = Max Input Voltage

Driver Lifetime vs. Driver Case Temperature

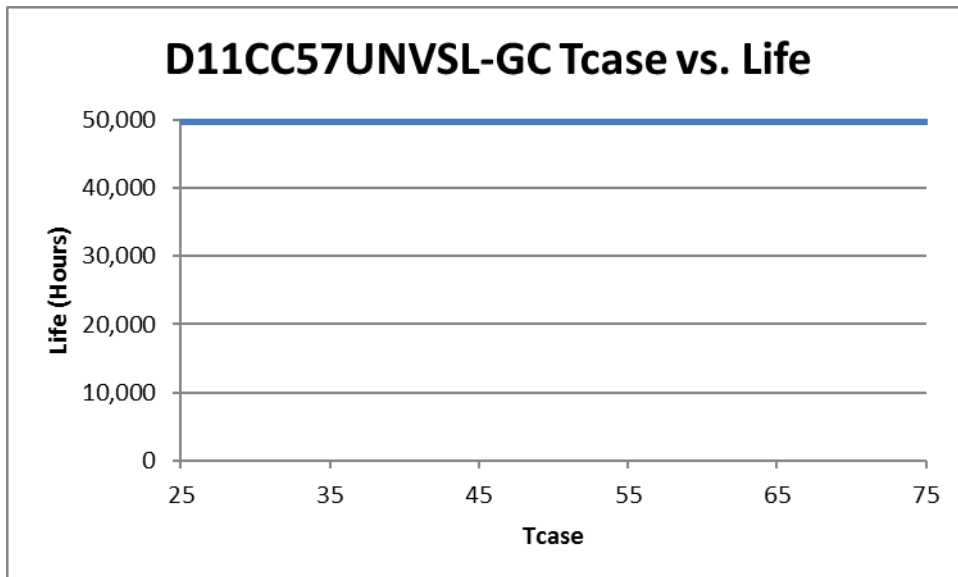

The Data curve provided predicts the LED Driver life based on the case temperature measured at the Tc location identified on the label or specification sheet. The Telecordia SR-332 standard is used to generate the prediction curves.

Application and operation performance specification information subject to change without notification.

Dimensional Diagram:

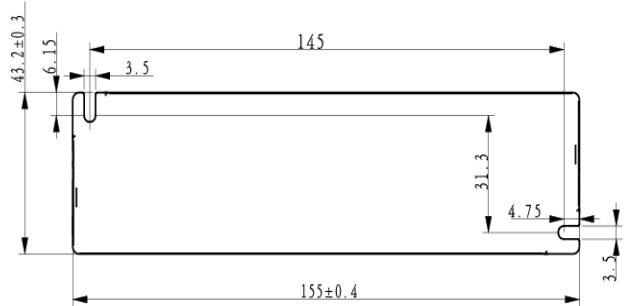
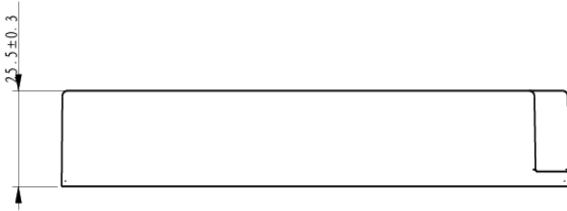

Length	6.10 in (155 mm)
Width	1.69 in (43 mm)
Height	1.00 in (25.5 mm)
Mounting Length	5.71 in (145 mm) w/ 1.22 in (31 mm) offset

Tc Location:

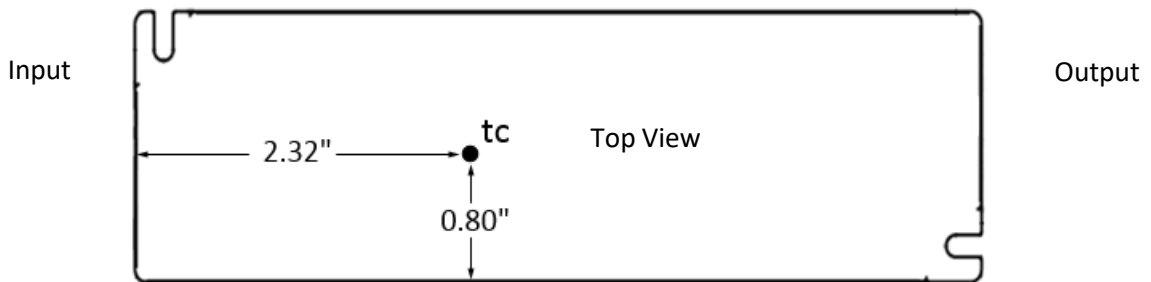

FCC Statement: This device complies with part 15 of the FCC Rules. Operation is subject to the following two conditions: (1) This device may not cause harmful interference, and (2) this device must accept any interference received, including interference that may cause undesired operation.

Warranty:

Universal Lighting Technologies warrants to the purchaser that each power supply will be free from defects in material or workmanship for a period of 5 years from the date of manufacture when properly installed per instructions and under normal operating conditions of use. Call 1-800-225-5278 for technical assistance.

Application and operation performance specification information subject to change without notification.