

Obsolete

D15CC55UNVD-K/KS



UNV DALI Dimming LED Driver

- 1500mA Constant Current Output
- Class 2, 55W Output
- DALI Dimming to 1%

Performance

Input Voltage	120 ~ 277 Vac
Input Current Max	0.56 /120V 0.24/277V
Input Power Max	63W
Input Frequency	50 - 60 (Hz)
Power Factor	> 0.95
THD max	< 20 %
Output Voltage	15-37V
Output Current	15mA - 1500mA
Output Power	55W
Line Regulation	±3 %
Load Regulation	±5 %
Output Current Ripple	<10% (Pk-Pk/avg)
Inrush Current	120V: 10.3A / 250uS
Peak / >50% Duration	277V: 17.5A / 250uS

- Inrush current complies with NEMA 410
 * Refer to charts for additional information

Physical

Length	4.93 in (125 mm)
Width	2.95 in (75 mm)
Height	1.00 in (25.4 mm)
Mounting Length	4.59 in (116.6 mm)
Weight (lbs)	1.0
Wire Trap / Plug-in Connectors for 18 AWG Solid Wire	

Protection

Over voltage, Under voltage, short circuit, and over temp.

Safety:

UL 8750 Type TL
 CSA 250.13

Ordering Information

Order Number	Description	Qty/Carton
D15CC55UNVD-K010C	Multi-Exit	10
D15CC55UNVD-KS10C	Bottom Exit w/ Studs	10

Environmental

EMI and RFI	Meets FCC part 15 (Class A) Non-Consumer Limits
Min. Operating Temperature	-40°C (-40°F)
Storage Temperature	-40°C to 85°C (-40°F to 185°F)
tc	85°C (185°F) max
Protection Rating	UL Dry & Damp
Transient Protection	IEEE C62.41 2.5kV/2.5kV

Wiring Diagram:

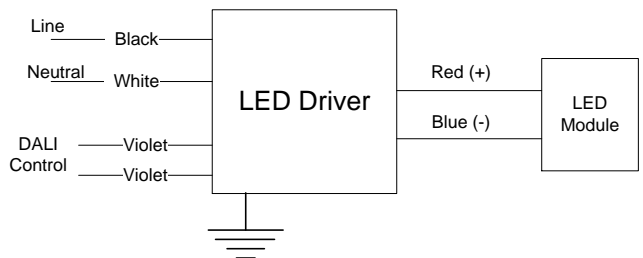

DALI Control

Compatible DALI protocol: IEC 62386
 Control circuit listed for Class 1 or Class 2 wiring
 Apply DALI control circuit to connectors marked DA



Application and operation performance specification information subject to change without notification.



Performance: Efficiency, THD, & Power Factor

Typical performance measurements are shown. The charts are to be used as a guideline and not for specification use.

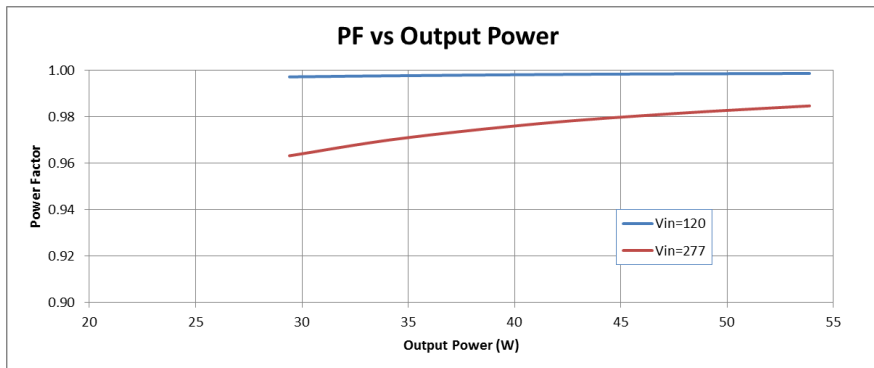
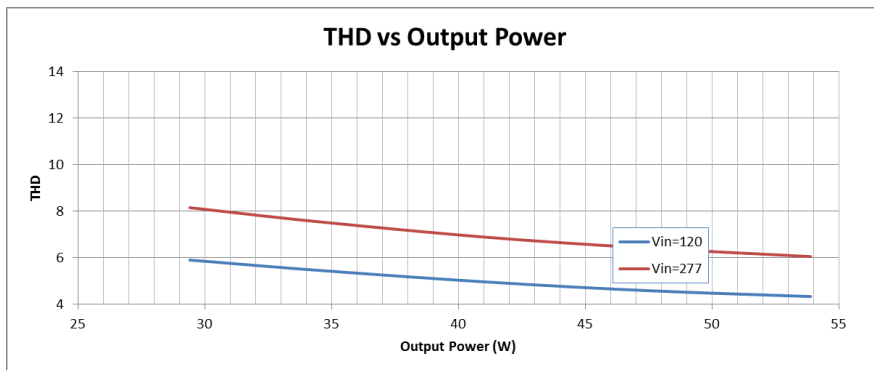
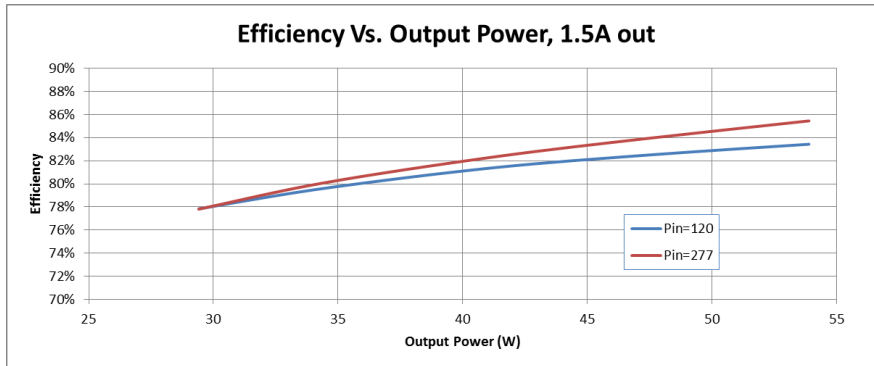

Output power based on maximum rated output current and varying load voltages.



Application and operation performance specification information subject to change without notification.



DALI Dimming

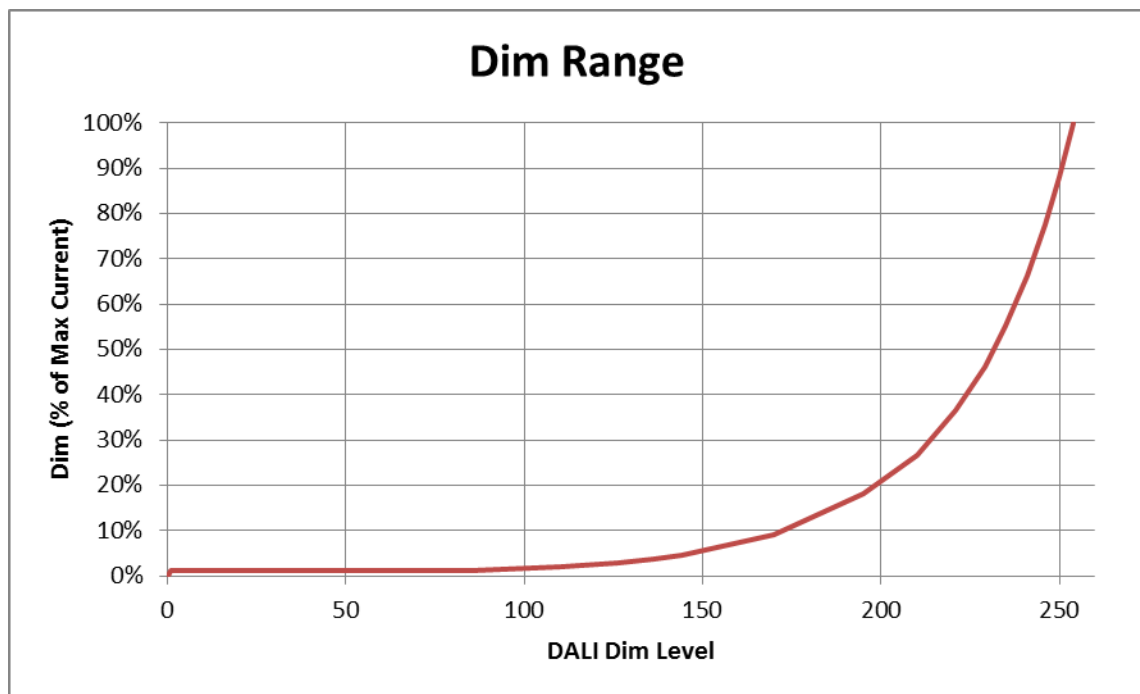

DALI Control

Compatible DALI protocol: IEC 62386
Control circuit listed for Class 1 or Class 2 wiring
Apply DALI control circuit to connectors marked DA

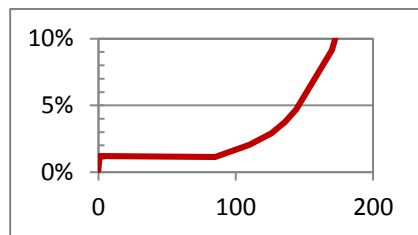

DALI Tuning

- Programmable output tuning can be performed using DALI commands that are part of the DALI standard.
- Tuned levels are based on a percentage of the maximum rated output current.
- See App Note EVD08 at <http://unvlt.com/products/drivers/application-notes/>
- Factory Pre-Tuning is available, contact your sales representative for more information.



Application and operation performance specification information subject to change without notification.



D15CC55UNVD-K/KS

Dimensions

-K

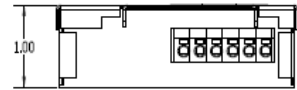
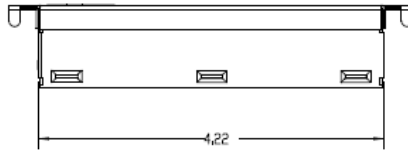
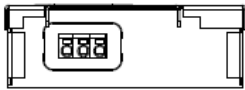
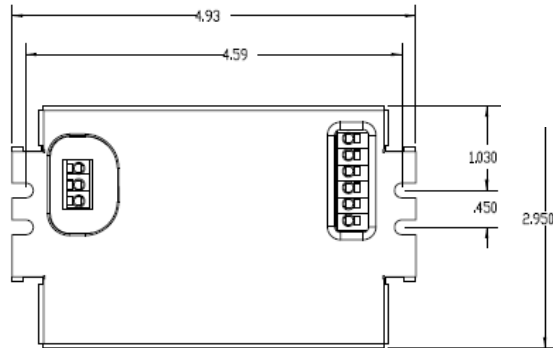

-KS

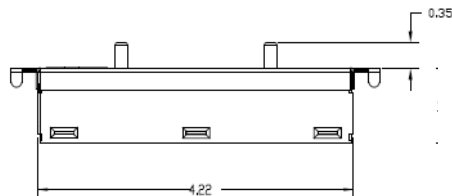
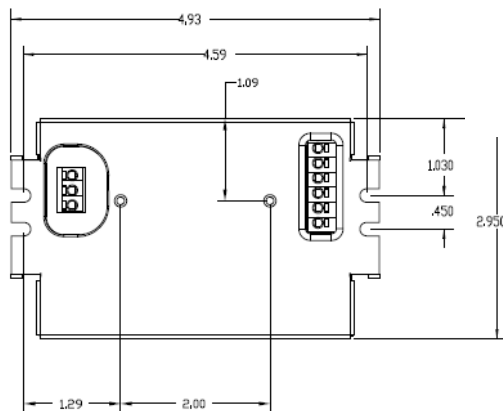

KS Provides lead exits at the bottom only



Application and operation performance specification information subject to change without notification.



Life vs. Driver Tcase

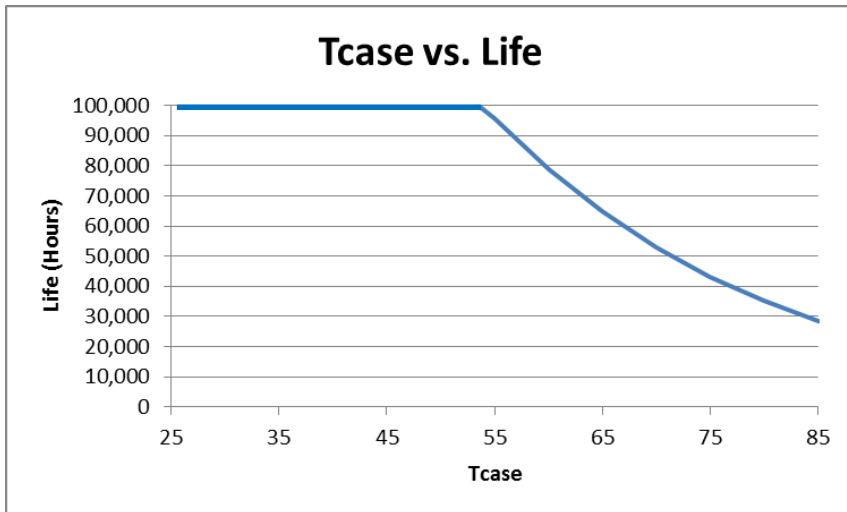

The Data curve provided predicts the LED Driver life based on the case temperature measured at the Tc location identified on the label or specification sheet. The Telecordia SR-332 standard is used to generate the prediction curves.

Tc Location:

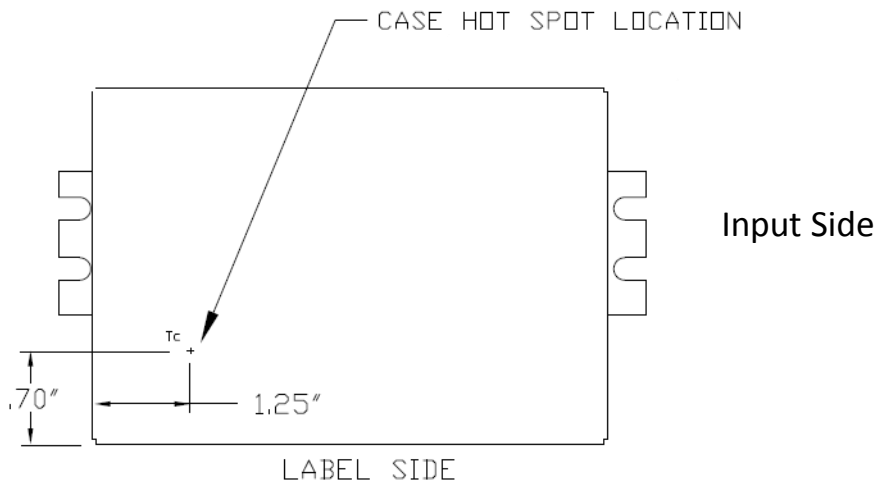

Application and operation performance specification information subject to change without notification.



D15CC55UNVD-K/KS

Conditions of Acceptability:

Use – For use only in (or with) complete equipment where the acceptability of the combination is determined by UL LLC.

1. The drivers are intended for building inside the enclosure of the end-use application with no vent openings. Acceptability of the LED driver with respect to mounting, spacing, casualty, temperature and segregation is to be determined as part of the end device evaluation.
2. The Drivers were evaluated as Type TL (Temperature Limited) for use at a $T_{ref\ max}$ and Measured T_{ref} temperature at T_{ref} as shown in the table below. See ILL. 5 for the T_c location on the units:

*Model	$T_{ref\ max}$	Measured T_{ref} @ 40°C Ambient Temperature
*D15CC55UNVD-K, D15CC55UNVD-KS	87°C	75°C

3. The drivers were also evaluated at the following temperature test condition with the results shown in the table below. See ILL. 5 for the T_c location on the units:

Model	Operating Conditions	Maximum Case Temp (T_c)	Maximum Ambient
D15CC55UNVD-K, D15CC55UNVD-KS	120 Vrms Input	85°C	51°C
	277 Vrms Input	85°C	65°C

4. The Ground bonding test was conducted from the green terminal connection to enclosure from a 40 amperes for a period of two minutes and the measured resistance was less than 0.01 ohms.
5. The maximum measured leakage current from the accessible driver enclosure conductively connected to the accessible Class 2 output were as follows:

Model	Maximum Measured Leakage Current mA / MIU	
	120V	277 V
D15CC55UNVD-K, D15CC55UNVD-KS	0.2	0.53

6. The terminal blocks for supply and load connection are intended for use with 18 AWG solid copper conductors with 0.33 in. strip length and are suitable for field and factory wiring.
7. The drivers are suitable for use in “DRY” and “DAMP” locations. Additional considerations will be necessary as these LED drivers are integrated into wet rated end devices (i.e. input and output supply connection means, accessibility of the output based on maximum voltage restrictions for wet rated Class 2 circuits, acceptability of markings, etc.).
8. The dimming circuit is isolated from the primary and the secondary circuits. And, the maximum available output parameters from the dimming circuit are within the limits for Class 2, inherently limited source as specified in the UL 1310 standard for Class 2 Power Units. Therefore, the dimming circuit is suitable for Class 1 or Class 2 wiring methods.
9. The maximum output voltage is greater than 42 VDC. Therefore, the output of the drivers is “LED driver Class 2” Per Annex “A” of CSA C22.2 250.13

FCC Statement: This device complies with part 15 of the FCC Rules. Operation is subject to the following two conditions: (1) This device may not cause harmful interference, and (2) this device must accept any interference received, including interference that may cause undesired operation.

Warranty:

Universal Lighting Technologies warrants to the purchaser that each power supply will be free from defects in material or workmanship for a period of 5 years from the date of manufacture when properly installed per instructions and under normal operating conditions of use. Call 1-800-225-5278 for technical assistance.



Application and operation performance specification information subject to change without notification.