

# D15CC55UNVTW-L/LS



## 1500mA LED Driver w/ Constant Power Tuning

- Universal (120-277V) Input Voltage
- Class 2, 55W Constant Current Output
- 0-10V Dimming to 1%

Performance	
Input Voltage	120 ~ 277 Vac
Input Current Max	0.56 /120V 0.24/277V
Input Power Max	63W
Input Frequency	50 - 60 (Hz)
Power Factor*	> 0.95
THD max*	< 20 %
Output Voltage	15V to 37V @ 1.50 Amps (Refer to Power Curve Chart) 15V to 56V @ 0.98 Amps
Max. Output Current	1500mA
Min. Dimming Current	15mA
Output Power	55W
Line Regulation	±3 %
Load Regulation	±5 %
Output Current Ripple	<10% (Pk-Pk/avg)
Inrush Current	120V: 10.3A / 250uS
Peak / >50% Duration	277V: 17.5A / 250uS

\* Refer to charts for additional information  
 - Harmonic Emissions comply with ANSI C82.77  
 - Inrush current complies with NEMA 410

Environmental	
EMI and RFI	Meets FCC part 15 (Class A) Non-Consumer Limits
Min. Operating Temperature	-40°C (-40°F)
Storage Temperature	-40°C to 85°C (-40°F to 185°F)
tc	85°C (185°F) max
Protection Rating	UL Dry & Damp
Transient Protection	IEEE C62.41 2.5kV/2.5kV

Physical	
Length	4.95 in
Width	2.39 in
Height	1.00 in
Mounting Length (L)	4.61" (feet)
Mounting Length (LS)	2.00" (#8-32 studs)
Weight (lbs)	1
Wire Trap / Plug-in Connectors for 18 AWG Solid Wire	

### Protection

Over voltage, short circuit, and over temp.

### Safety:

UL 8750 & CSA 250.13-12  
 Class P

D15CC55UNVTW-LN0C	Multi-Exit	10
D15CC55UNVTWLSN0C	Bottom Exit w/ Studs	10

### Wiring Diagram:

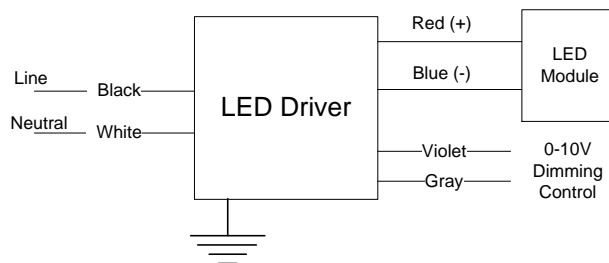

Application and operation performance specification information subject to change without notification.

## Programmable Tuned Output Settings

- This Everline LED Driver can be configured to set its current output to a selected fraction of their maximum rated design level. This function is called tuning (or also high-end trim) and it can be implemented with the LPTC01U using the Selector rotary switches. Tuning assignments are stored in driver memory and are not lost when power is removed. All factory produced drivers are tuned to maximum output unless otherwise noted on the label.
- Tuning SET Levels are listed in the table to the right. The SET Level corresponds to an associated Output Current value.
- Refer to application note EVD09 at [www.unvlt.com](http://www.unvlt.com) for additional information.

Set Value	Output Current (A)
100	1.50
99	1.48
98	1.46
97	1.45
96	1.43
95	1.42
94	1.40
93	1.39
92	1.37
91	1.36
90	1.34
89	1.33
88	1.31
87	1.30
86	1.28
85	1.27
84	1.25
83	1.24
82	1.22
81	1.21

Set Value	Output Current (A)
80	1.19
79	1.18
78	1.16
77	1.15
76	1.13
75	1.12
74	1.10
73	1.09
72	1.07
71	1.06
70	1.04
69	1.03
68	1.01
67	1.00
66	0.98
65	0.97
64	0.95
63	0.94
62	0.92
61	0.91

Set Value	Output Current (A)
60	0.89
59	0.88
58	0.86
57	0.85
56	0.84
55	0.82
54	0.81
53	0.79
52	0.78
51	0.76
50	0.75
49	0.73
48	0.72
47	0.70
46	0.69
45	0.67
44	0.66
43	0.64
42	0.63
41	0.61
40	0.60

## Driver Operating Range

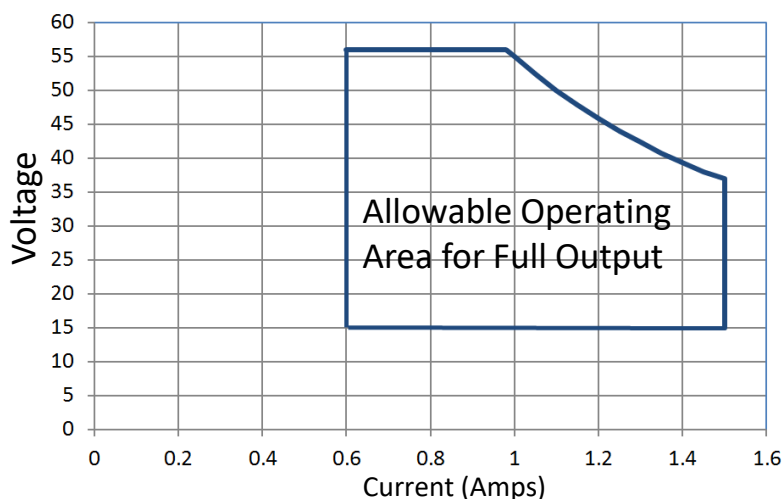

For points along the curve:

- \* Maximum output current will not exceed 1.5A.
- \* Maximum output voltage will not exceed 56V.
- \* Output power ( Volts x Amps) will not exceed 55W.

Application and operation performance specification information subject to change without notification.

## 0-10V Dimming

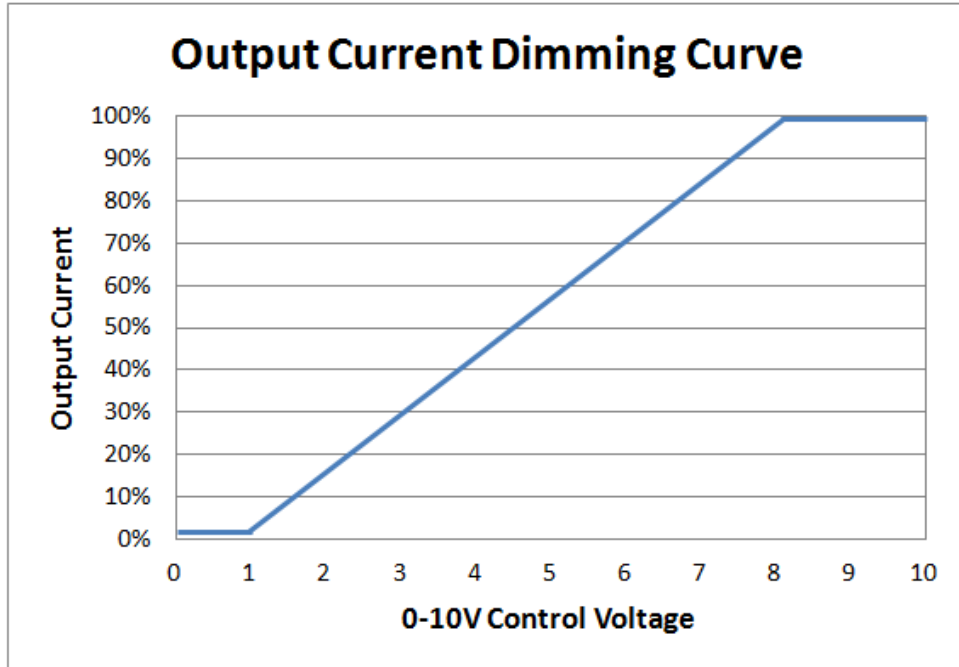

### 0-10V Analog Dimming Interface

- Analog 0 to 10 vDC Voltage Control
- Use Violet (+) & Gray (-) for connection to 0-10vDC.
- 10v = maximum output, 0v = minimum output
- Wiring Violet & Gray together provides min. light output.
- Capping Violet & Gray separately provides 100% light output.
- 0-10V interface must be wired as a Class 2 Circuit.
- Driver will source a maximum of 200uA for control needs.
- Controller must sink current from the 0-10V control leads.

Application and operation performance specification information subject to change without notification.

## Performance: Efficiency, THD, & Power Factor

Typical performance measurements are shown. The charts are to be used as a guideline and not for specification use.

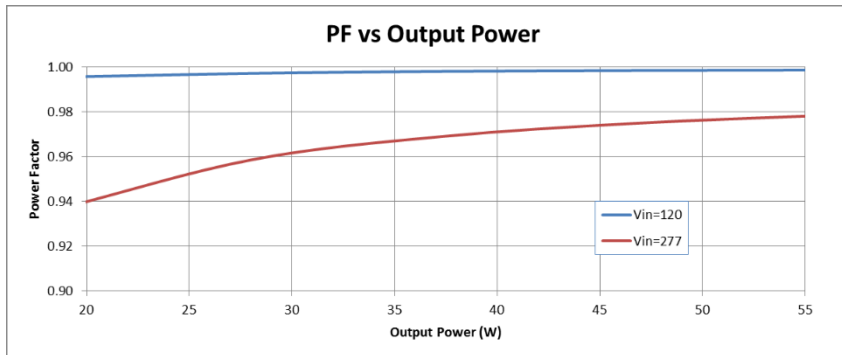
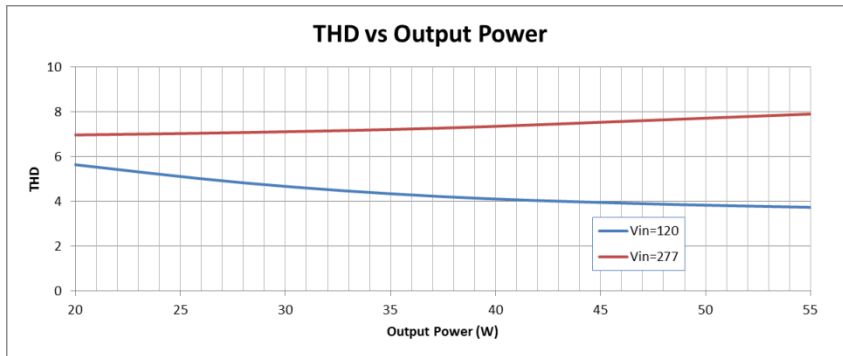
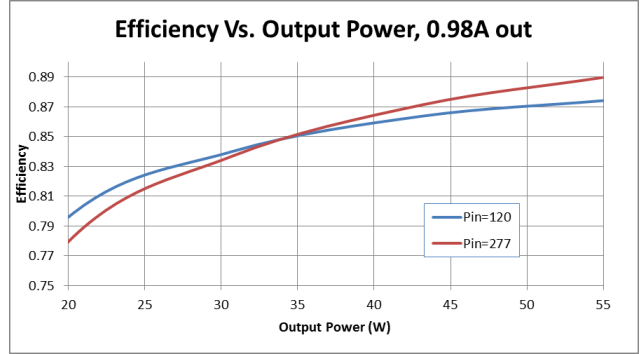
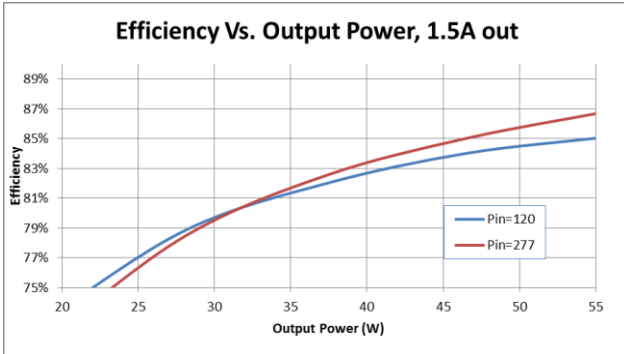

Output power based on maximum rated output current and varying load voltages.

Application and operation performance specification information subject to change without notification.

## Dimensions

-L

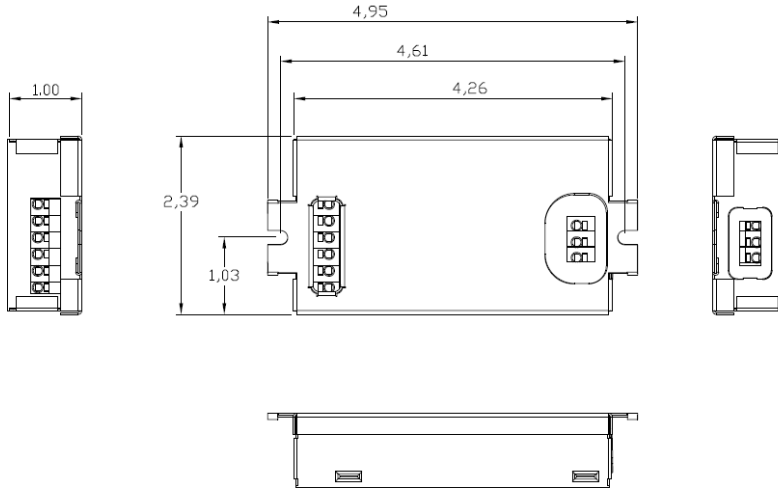

LS

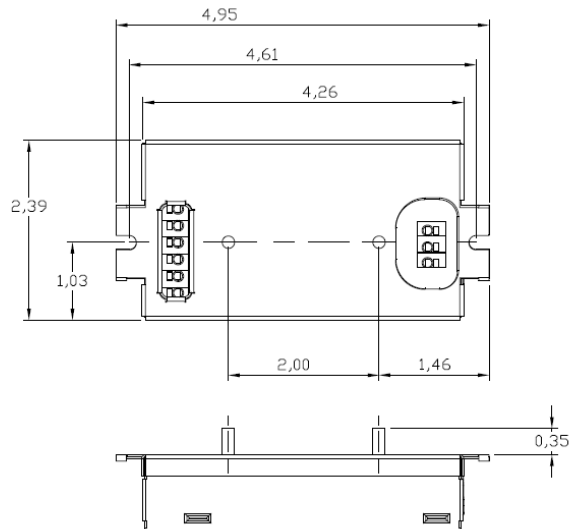

LS Provides lead exits at the bottom only

Application and operation performance specification information subject to change without notification.

## Life vs. Driver Tcase

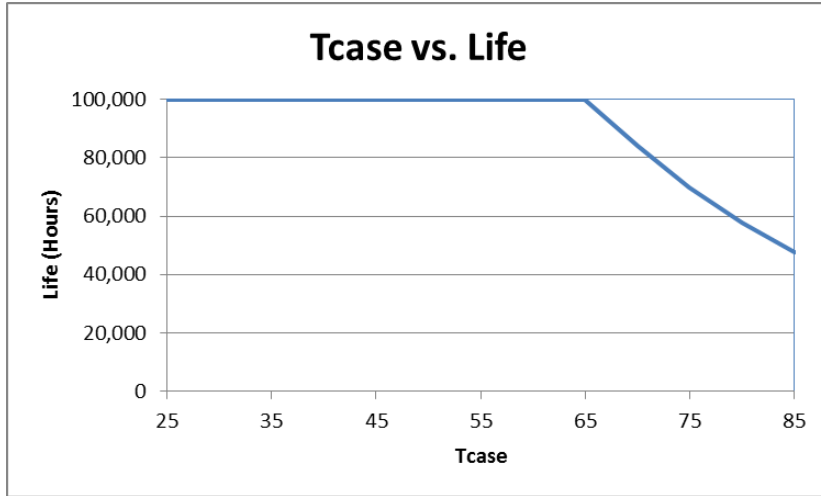

The Data curve provided predicts the LED Driver life based on the case temperature measured at the Tc location identified on the label or specification sheet. The Telecordia SR-332 standard is used to generate the prediction curves.

## Tc Location:

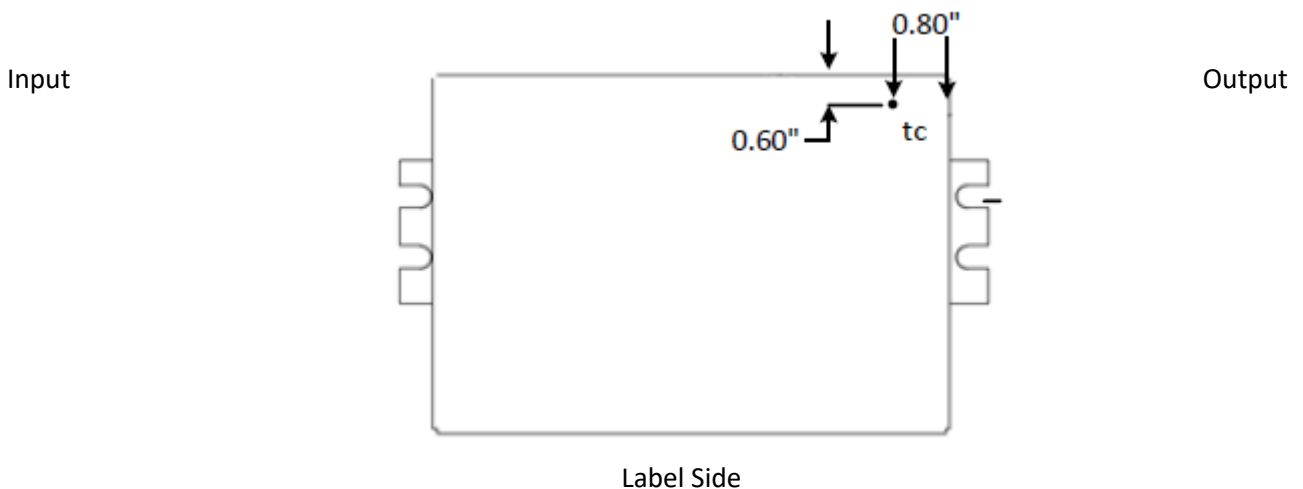

Application and operation performance specification information subject to change without notification.

FCC Statement: This device complies with part 15 of the FCC Rules. Operation is subject to the following two conditions: (1) This device may not cause harmful interference, and (2) this device must accept any interference received, including interference that may cause undesired operation.

**Warranty:**

Universal Lighting Technologies warrants to the purchaser that each power supply will be free from defects in material or workmanship for a period of 5 years from the date of manufacture when properly installed per instructions and under normal operating conditions of use. Call 1-800-225-5278 for technical assistance.

Application and operation performance specification information subject to change without notification.