

D15CC55UVPEL-C

1500mA Programmable LED Driver

- Universal (120-277V) Input Voltage
- Class 2, 55W Constant Current Output
- IoT Ready Profile 1 Digital Interface



Performance

Input Voltage	120 ~ 277 Vac
Input Current Max	0.56 / 120V 0.24 / 277V
Input Power Max	65W
Input Frequency	50 - 60 (Hz)
Power Factor	> 0.95 @ max load
THD max	< 20% @ max load
Output Voltage	15V to 37V @ 1.50 Amps (Refer to Power Curve Chart) 15V to 56V @ 0.98 Amps
Max. Output Current	450 - 1500mA
Min. Dimming Current	15mA
Output Power	55W
Standby Power	< 2.8W @ 120Vac < 3.5W @ 277Vac
Line Regulation	±3 %
Load Regulation	±5 %
Output Current Ripple	<10% (Pk-Pk/avg)
Inrush Current*	120V: 19A / 373uS Peak / >10% Duration 277V: 47A / 271uS

* Source impedance per NEMA 410

Digital Interface

Power Supply	50mA @ 12Vdc
Communication Protocol	Enlighted Sensor Interface V4.8
Connection	RJ45
IoT Ready Profile	Profile 1 Digital Dimming Interface
Energy Metering Profile	EM Command Group

Physical

Length	14.25 in (362 mm)
Width	1.18 in (30 mm)
Height	1.00 in (25.4 mm)
Mounting Length	13.75 in (349.3 mm)
Weight (lbs)	1.0
Wire Trap / Plug-in Connectors for 16-22 AWG Solid Wire Strip length 0.33 in	

Environmental

EMI and RFI	Meets FCC part 15 (Class A) Non-Consumer Limits
Operating Temperature	-40°C to 50°C (-40°F to 122°F)
Storage Temperature	-40°C to 85°C (-40°F to 185°F)
tc	85°C max for warranty 90°C max for UL
Protection Rating	UL Dry & Damp
Transient Protection	IEEE C62.41 2.5kV

Protection

Over Voltage, Under Voltage, Short Circuit, Over Temp

Safety:

UL 8750 & CSA 250.13
UL Class P



Ordering Information

Order Number	Description	Qty/Carton
D15CC55UVPEL-C010C	Standard Product	10

Application and operation performance specification information subject to change without notification.

D15CC55UVPEL-C

Wiring Diagram:

RJ45 Interface		
	Sensor	Driver
Pin 4	GND	Aux (-)
Pin 5	VCC	Aux (+)
Pin 7	RX	TX
Pin 8	TX	RX

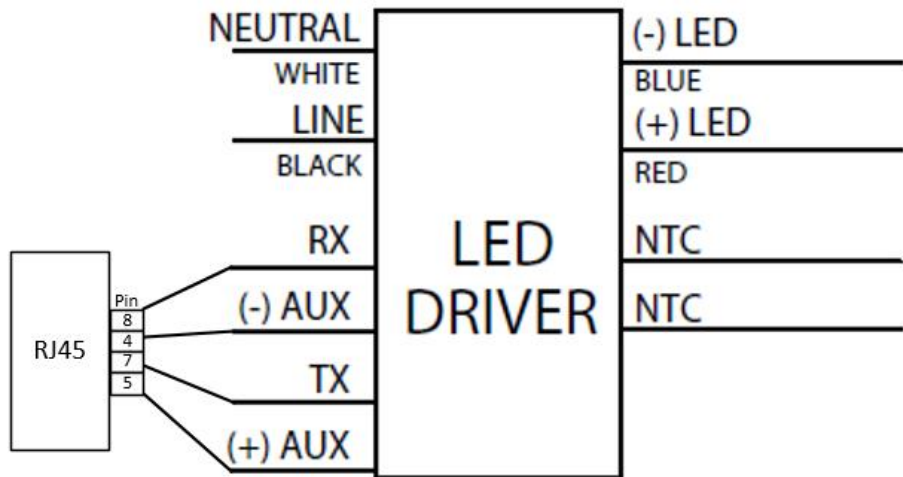

Driver Operating Range:

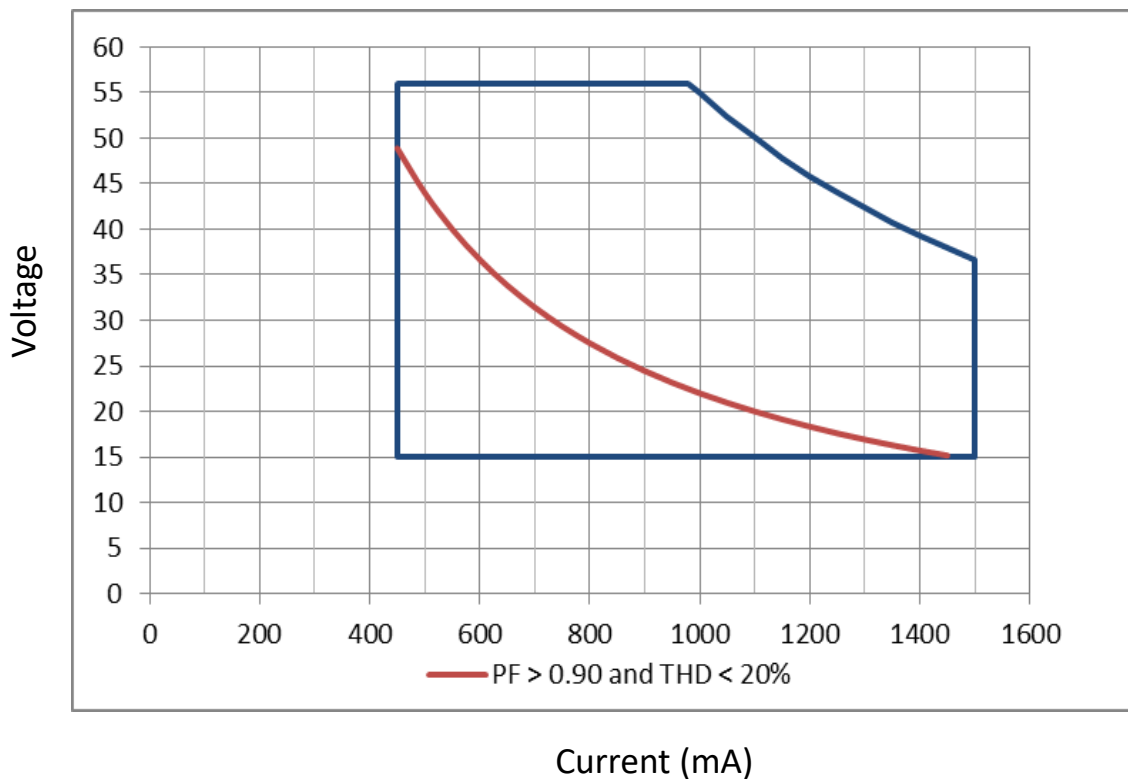

Application and operation performance specification information subject to change without notification.

Programmable Features	
Output Current	
Dim Current Floor	

Retrievable Data	
Power Measurement*	
Power Uptime	
Internal Temperature	
Dim Level	
Driver Model Number	

* Power Measurement accuracy: +/-3% for output voltage 20-56Vdc; +/-5% for output voltage <20Vdc

Programming System	
Software	EVERset Programming Software
Hardware	LDPCELOA Configuration Tool
Driver Interface	Wired via RJ45 Connector

Digital Dimming

Digital Dimming to 1%

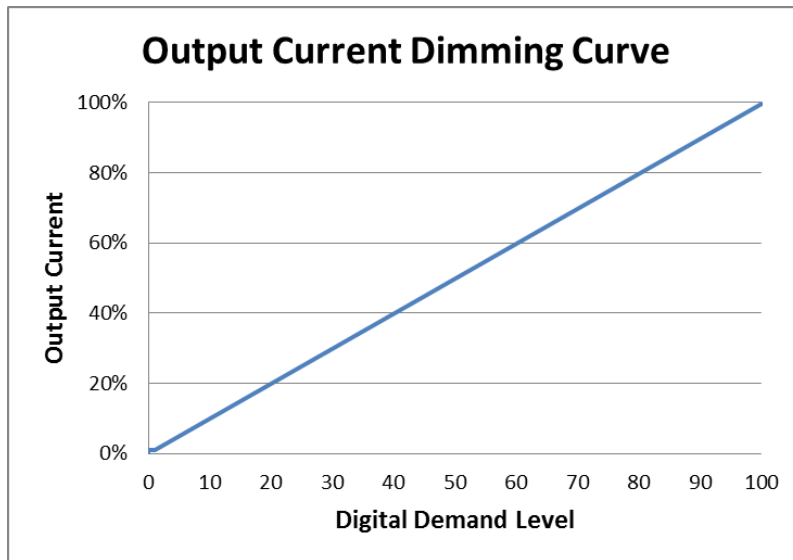

Programmable Dimming Features		
Feature	Range	Factory Default
Maximum Output Current	450 - 1500mA	default = 1500mA

Application and operation performance specification information subject to change without notification.

Performance: Efficiency

Typical performance measurements are shown. The charts are to be used as a guideline and not for specification use.

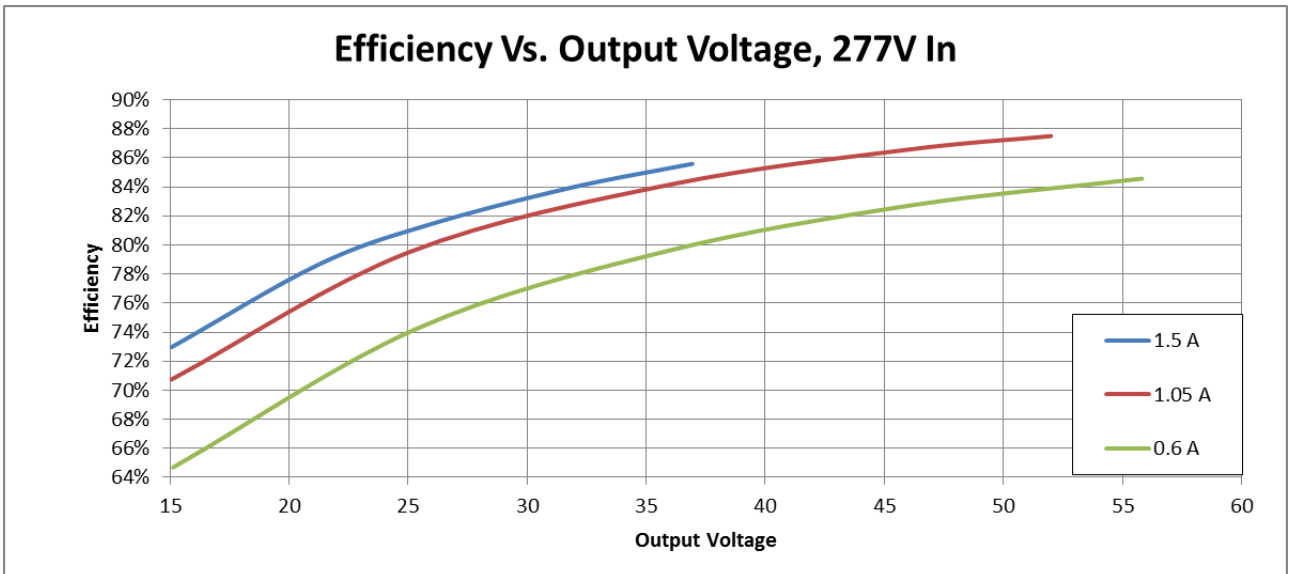
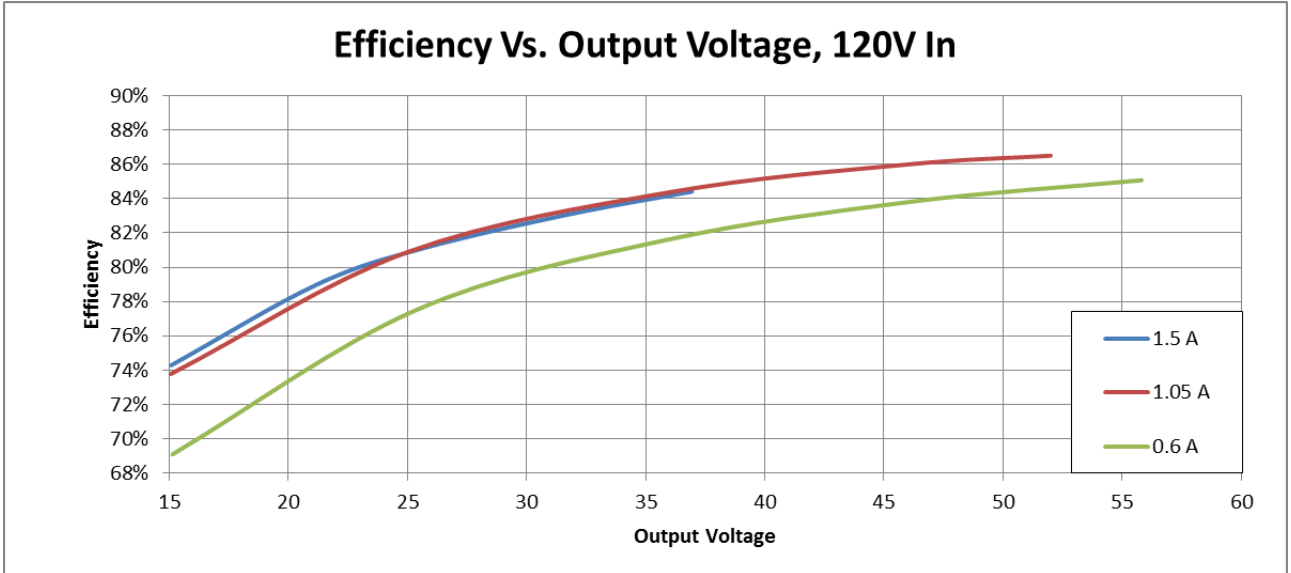

Application and operation performance specification information subject to change without notification.

Performance: Total Harmonic Distortion, & Power Factor

Typical performance measurements are shown. The charts are to be used as a guideline and not for specification use.

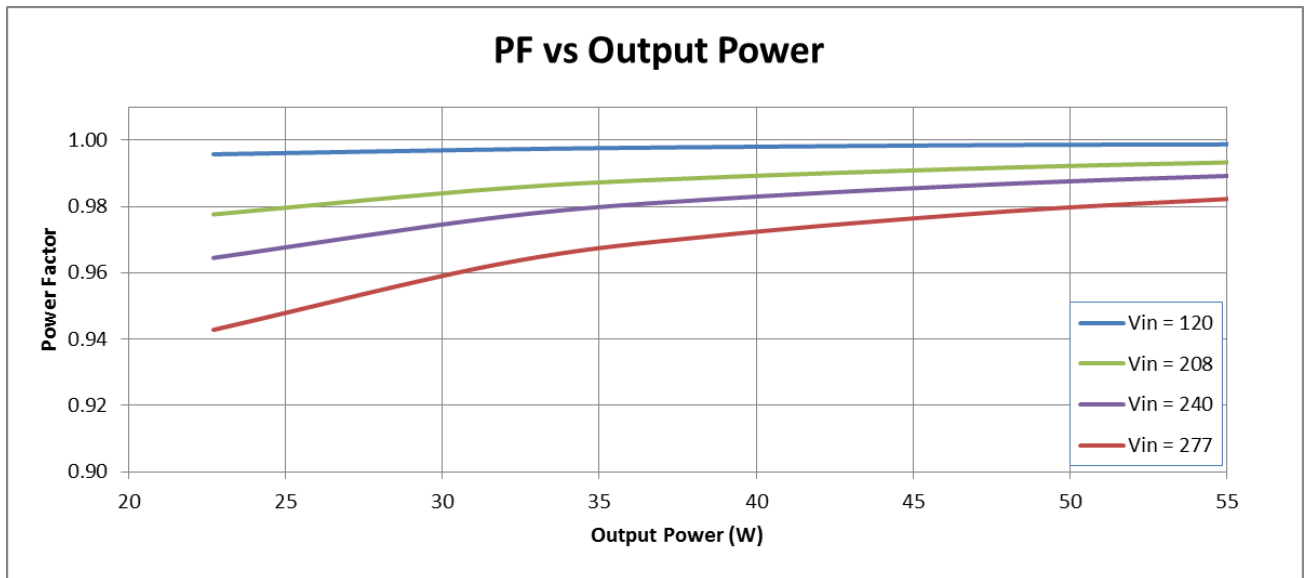
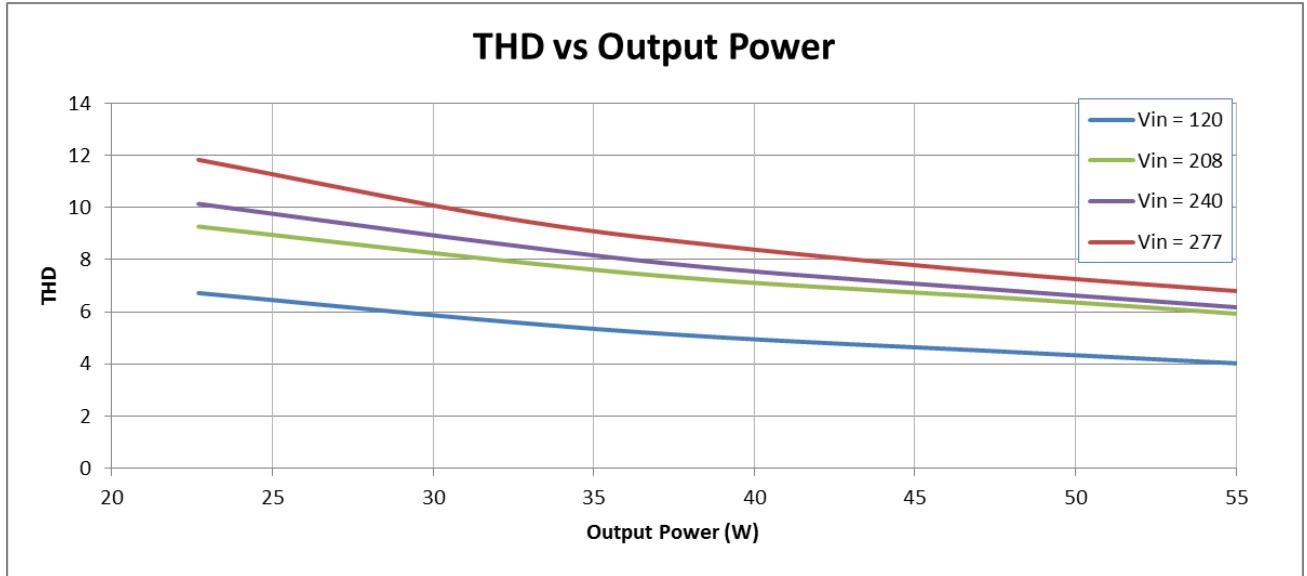

Output power based on maximum rated output current and varying load voltages.

Application and operation performance specification information subject to change without notification.

Transient Protection		
Transient	Differential Mode (L-N)	Common Mode (L-G, N-G, L&N-G)
IEEE C62.41 100kHz Ring Wave (200A maximum)	> 2.5kV	> 2.5kV

Isolation						
Isolation	Input	Output	Digital Dim	Auxiliary	NTC	Enclosure
Input	-	2xU + 1kV	2xU + 1kV	2xU + 1kV	2xU + 1kV	2xU + 1kV
Output	2xU + 1kV	-	2xU + 1kV	2xU + 1kV	Non-isolated	700V
Digital Dim	2xU + 1kV	2xU + 1kV	-	Non-isolated	2xU + 1kV	2xU + 1kV
Auxiliary	2xU + 1kV	2xU + 1kV	Non-isolated	-	2xU + 1kV	2xU + 1kV
NTC	2xU + 1kV	Non-isolated	2xU + 1kV	2xU + 1kV	-	700V
Enclosure	2xU + 1kV	700V	2xU + 1kV	2xU + 1kV	700V	-

U = Max Input Voltage

Driver Lifetime vs. Driver Case Temperature

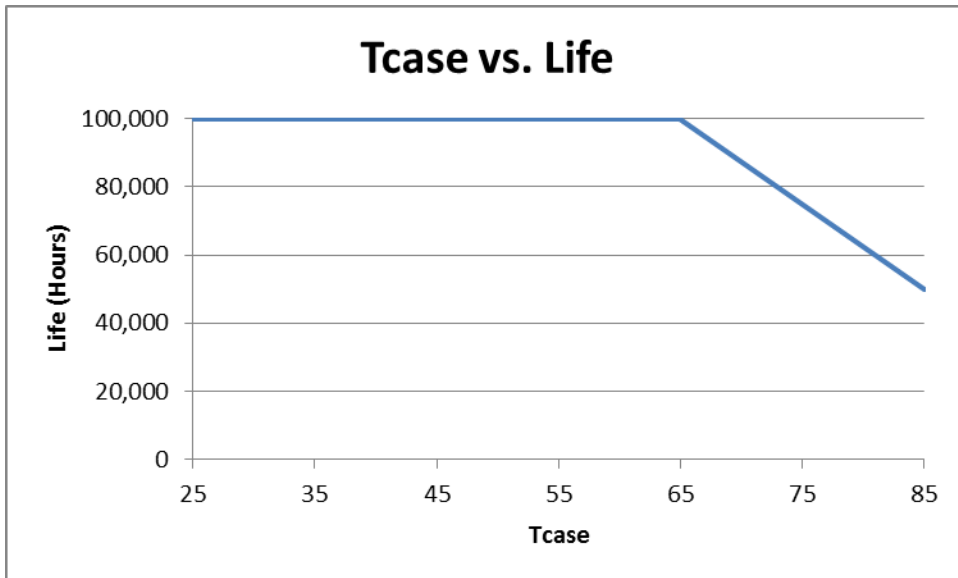

The Data curve provided predicts the LED Driver life based on the case temperature measured at the Tc location identified on the label or specification sheet. The Telecordia SR-332 standard is used to generate the prediction curves.

Application and operation performance specification information subject to change without notification.

Dimensional Diagram:

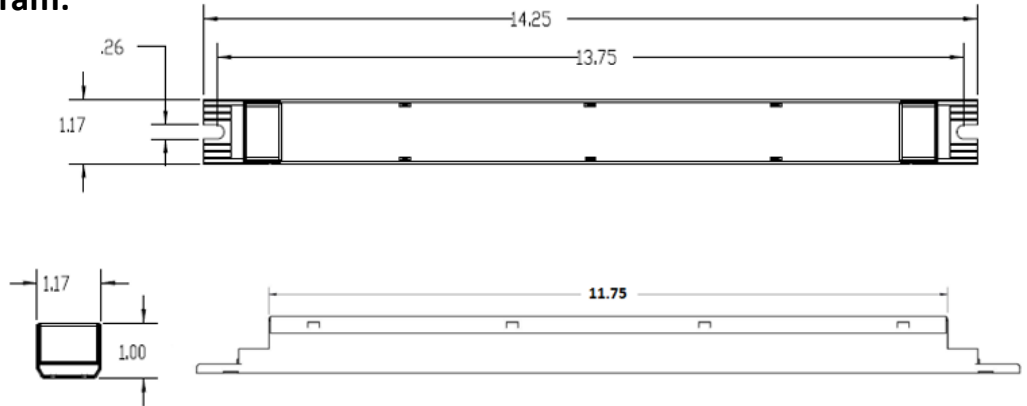

Tc Location:

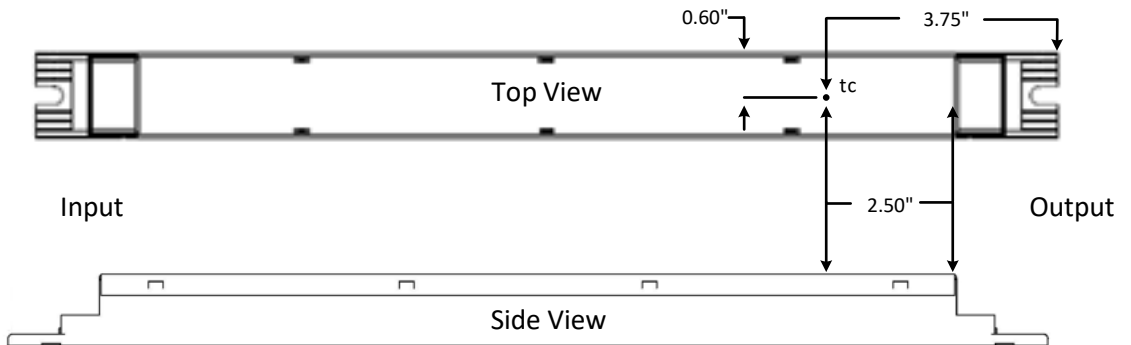

FCC Statement: This device complies with part 15 of the FCC Rules. Operation is subject to the following two conditions: (1) This device may not cause harmful interference, and (2) this device must accept any interference received, including interference that may cause undesired operation.

Warranty:

Universal Lighting Technologies warrants to the purchaser that each power supply will be free from defects in material or workmanship for a period of 5 years from the date of manufacture when properly installed per instructions and under normal operating conditions of use. Call 1-800-225-5278 for technical assistance.

Application and operation performance specification information subject to change without notification.