

Obsolete

# D20CC180UNVPWX24-F

## 2000mA Programmable LED Driver

- 180W constant current output with 0-10V dimming
- Full featured programmability with 24Vdc 100mA auxiliary output
- Low standby power (<0.5W) in dim-to-off state



### Performance

Input Voltage	120 ~ 277 Vac
Input Current Max	1.77 / 120V 0.75 / 277V
Input Power Max	200W
Input Frequency	50 - 60 (Hz)
Power Factor	> 0.95 @ max load
THD max	< 20 % @ max load
Output Voltage (Refer to Power Curve Chart)	50V to 90V @ 2.00 Amps 50V to 130V @ 1.39 Amps
Max. Output Current	2000mA
Min. Dimming Current	50mA
Output Power	180W
Standby Power	< 0.5W @ 120Vac < 0.5W @ 277Vac
Line Regulation	±3 %
Load Regulation	±5 %
Output Current Ripple	<10% (Pk-Pk/avg)
Inrush Current* Peak / >10% Duration	120V: 43A / 184uS 277V: 99A / 182uS

\* source impedance per NEMA 410

### Protection

Over Voltage, Under Voltage, Short Circuit, Over Temp Safety:

UL 8750 & CSA 250.13  
UL Class P



### Auxiliary Output

Output Voltage	24Vdc
Output Current	100 mA

### Physical

Length	9.50 in
Width	2.38 in
Height	1.58 in
Mounting Length	8.90 in
Weight (lbs)	2.6
Lead Lengths (+/- 1 in)	
Blk, Wht, Purple, Gray	11.5 in
Red(+), Blue(-), Orange, Yellow/Black	11.5 in

Lead-wires are 18 AWG 105°C / 600V solid copper.

### Environmental

EMI and RFI	Meets FCC part 15 (Class A) Non-Consumer Limits
Operating	-40°C to 55°C (-40°F to 131°F)
Storage Temperature	-40°C to 85°C (-40°F to 185°F)
tc	85°C max for warranty 85°C max for UL
Location Rating	UL Dry & Damp, Type HL
IP Rating	IP66
Transient Protection	IEEE C62.41 6kV**

\*\*Driver uses MOVs for transient protection.

Refer to application note EVD07 at [www.unvlt.com](http://www.unvlt.com) for additional information on Hi-Pot Testing.

### Wiring Diagram:

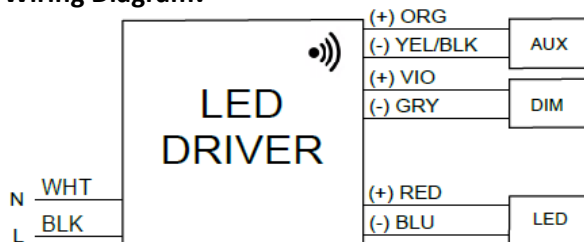

### Ordering Information

Order Number	Description	Qty/Carton
D20CC180UNVPWX24-F010C	2000mA 180W	10



Application and operation performance specification information subject to change without notification.

Obsolete

# D20CC180UNVPWX24-F

## Programmable Features

Output Current
Minimum Dimming Level
Dim-to-Off
Dimming Curve (Linear, Linear Soft Start, Logarithmic)
Lumen Maintenance
Thermal Overload

## Programming System

Software	EVERset Programming Software
Hardware	LDPC000A Configuration Tool
Driver Interface	Wireless via RFID

\*Refer to application notes EVD10, EVD11 and EVD15 at [www.unvlt.com](http://www.unvlt.com) for additional information on programmable features.

## Driver Operating Range:

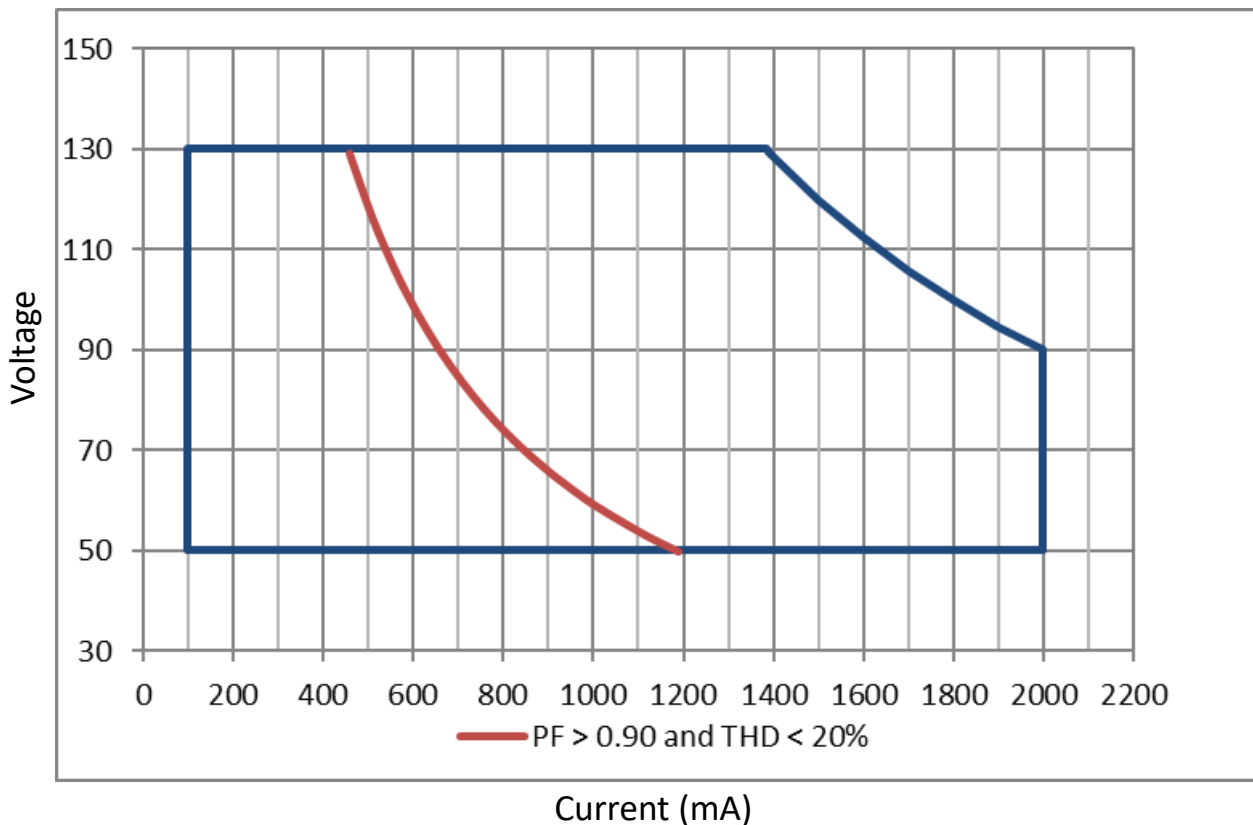

EVERLINE™

Application and operation performance specification information subject to change without notification.



## 0-10V Dimming

Linear Dimming to 10%

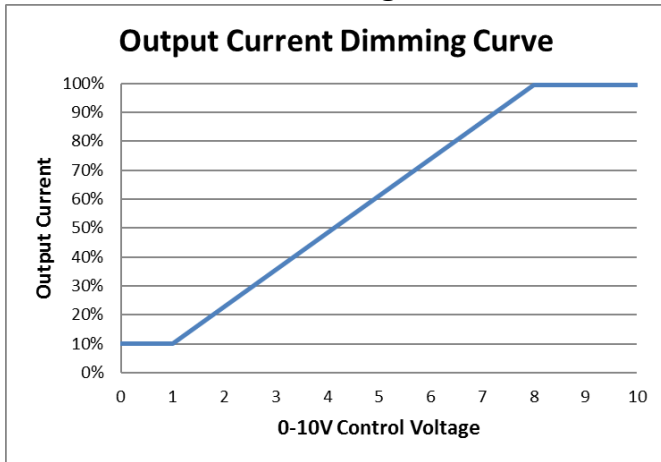

Linear Dimming w/ Dim-to-Off

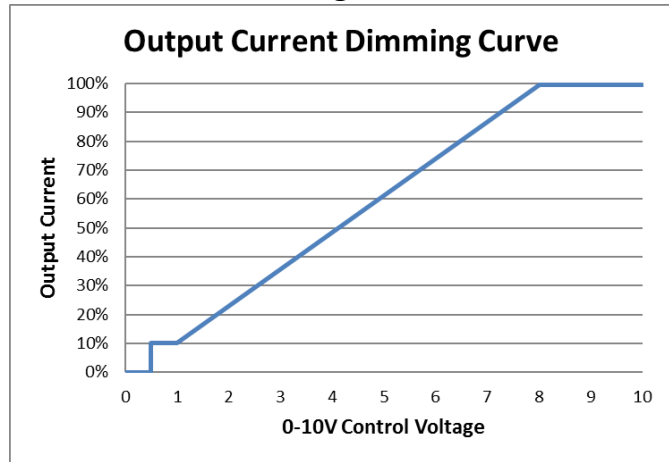

\* Driver ships with Dim-to-Off disabled. Dim-to-Off must be enabled through the EVERset programming software.

### 0-10V Analog Dimming Interface

- Analog 0 to 10 Vdc Voltage Control
- Use Violet (+) & Gray (-) for connection to 0-10 Vdc.
- 10V = maximum output, 0V = dim-to-off or minimum programmed output
- 0-10V interface can be wired as Class 1 or Class 2 Circuit.
- Driver will source a maximum of 165uA for control needs.
- Controller must sink current from the 0-10V control leads.

Programmable Dimming Features		
Feature	Range	Factory Default
Maximum Output Current	100 - 2000mA	default = 2000mA
Minimum Dimming Level	50 - 1000mA	default = 200mA
Dimming Curve	(Linear, Linear Soft Start, Logarithmic w/ factor 1 to 7)	default = Linear
Dimming Control Voltage Range		
Max Bright Control Voltage	7 - 9Vdc	default = 8Vdc
Min Dim Level Control Voltage	1 - 3Vdc	default = 1Vdc
Dim-to-Off	0.1 - 1.7Vdc; 0 = disabled	default = 0Vdc

\* Refer to application note EVD10 at [www.unvlt.com](http://www.unvlt.com) for additional information on programmable dimming features.



Application and operation performance specification information subject to change without notification.



## Driver Thermal Overload Protection

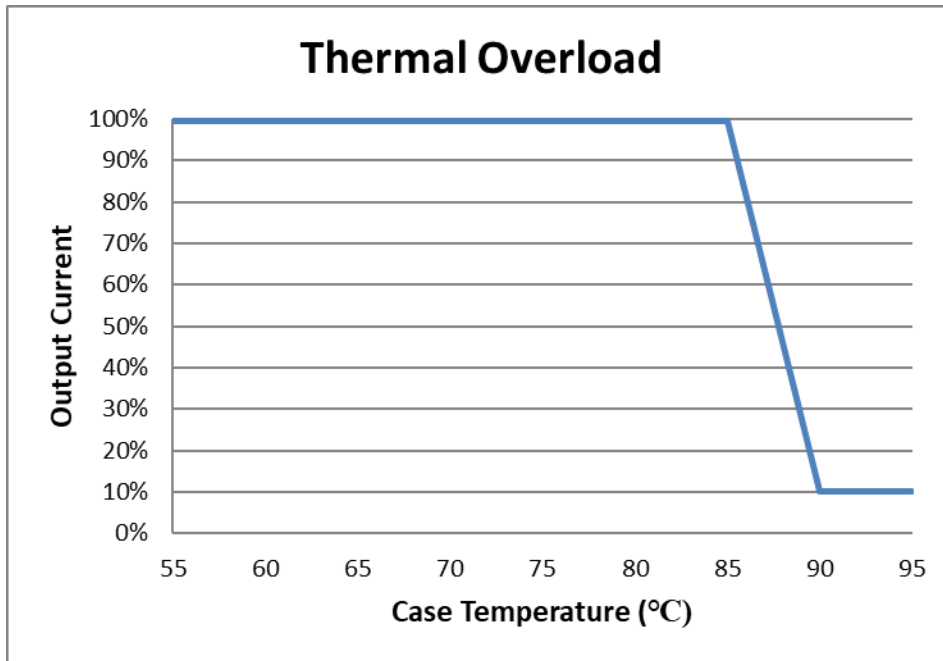

Example with the Output Current set to 2000mA, Starting Temperature set to 85°C, Ending Temperature set to 90°C and Ending Output Current set to 200mA (10%).

### Programmable Thermal Overload

Feature	Range	Factory Default
Starting Temperature	25 - 89°C	default = disabled
Ending Temperature	26 - 90°C	default = disabled
Ending Output Current	50 - 2000mA	default = disabled

\*Refer to application note EVD15 at [www.unvlt.com](http://www.unvlt.com) for additional information on Programmable Thermal Overload.



Application and operation performance specification information subject to change without notification.



## Performance: Efficiency

Typical performance measurements are shown. The charts are to be used as a guideline and not for specification use.

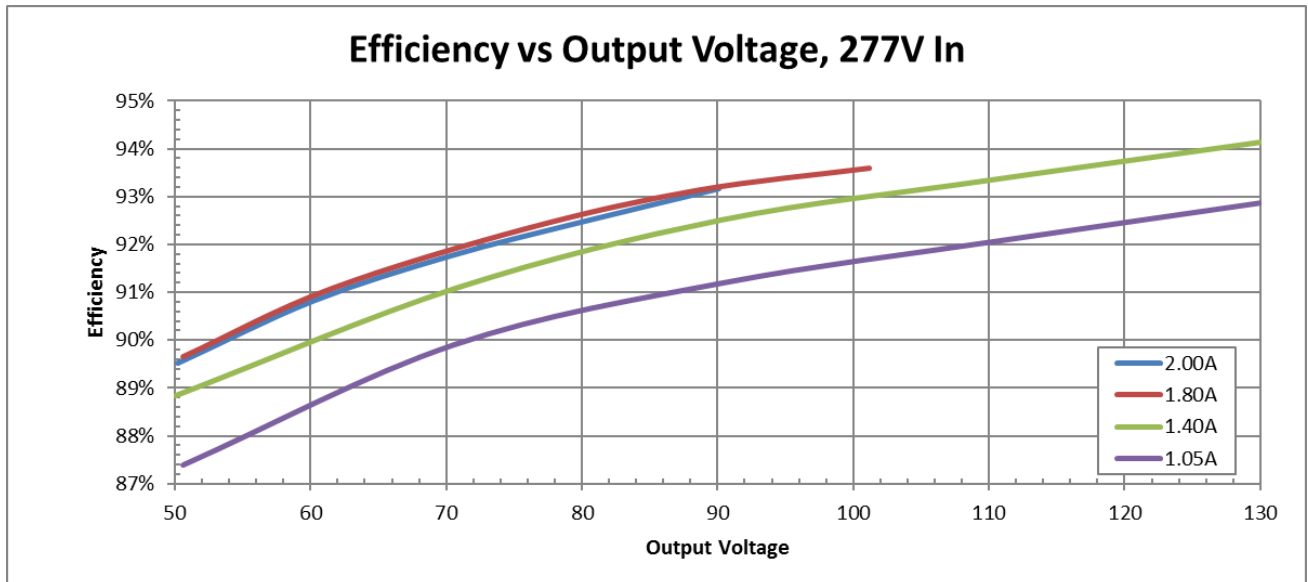
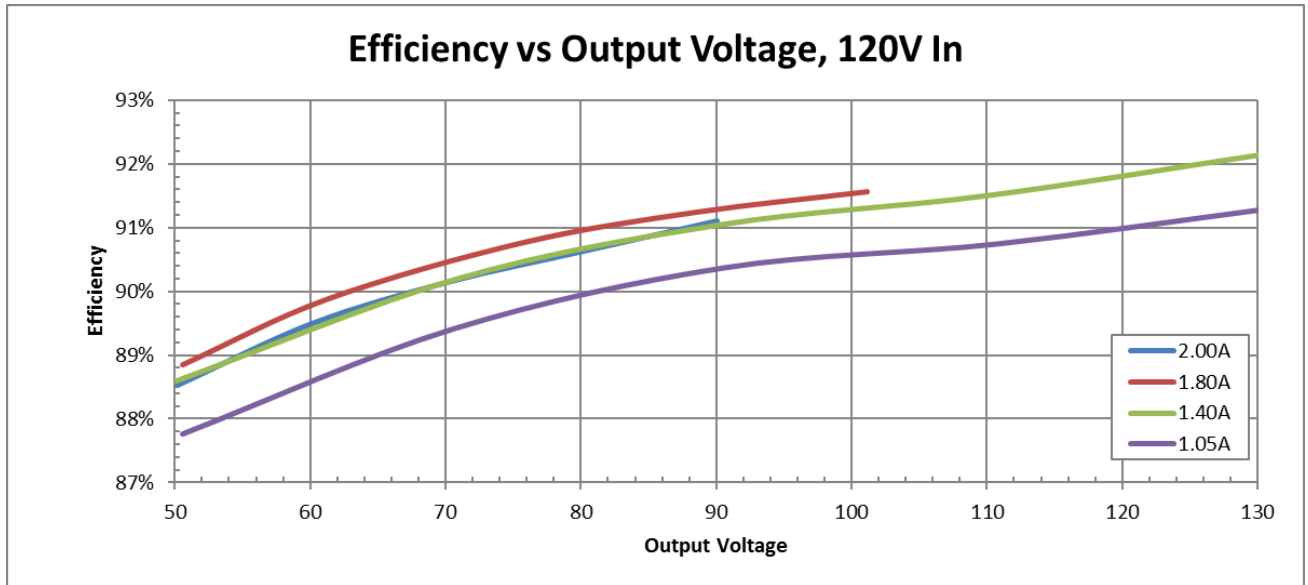

Application and operation performance specification information subject to change without notification.



## Performance: Total Harmonic Distortion, & Power Factor

Typical performance measurements are shown. The charts are to be used as a guideline and not for specification use.

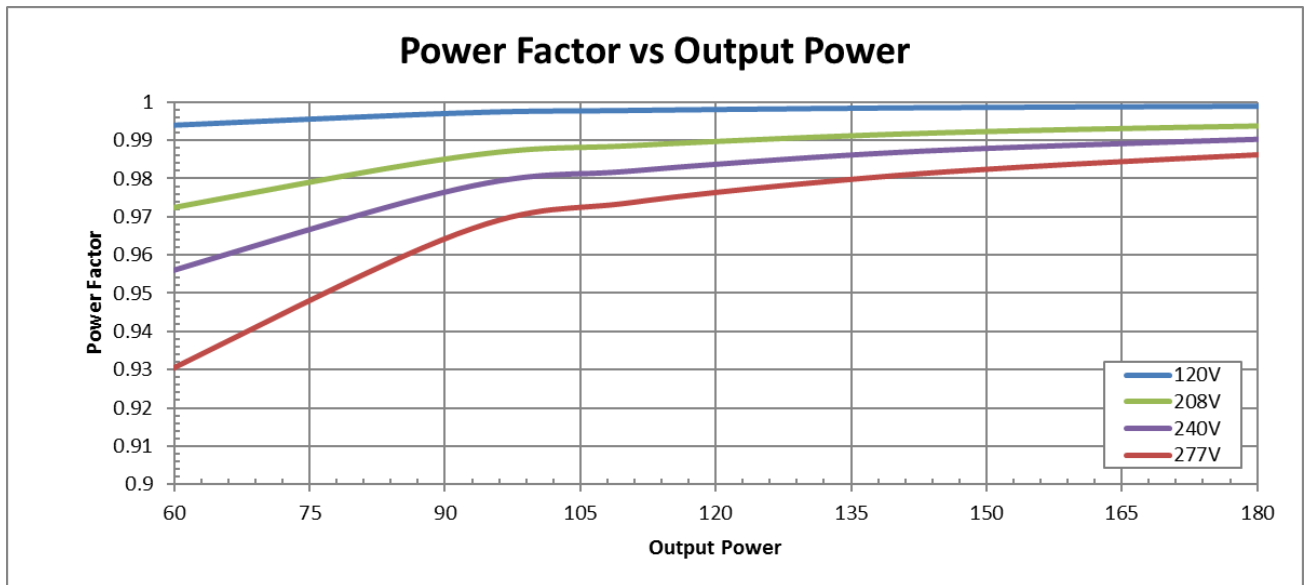
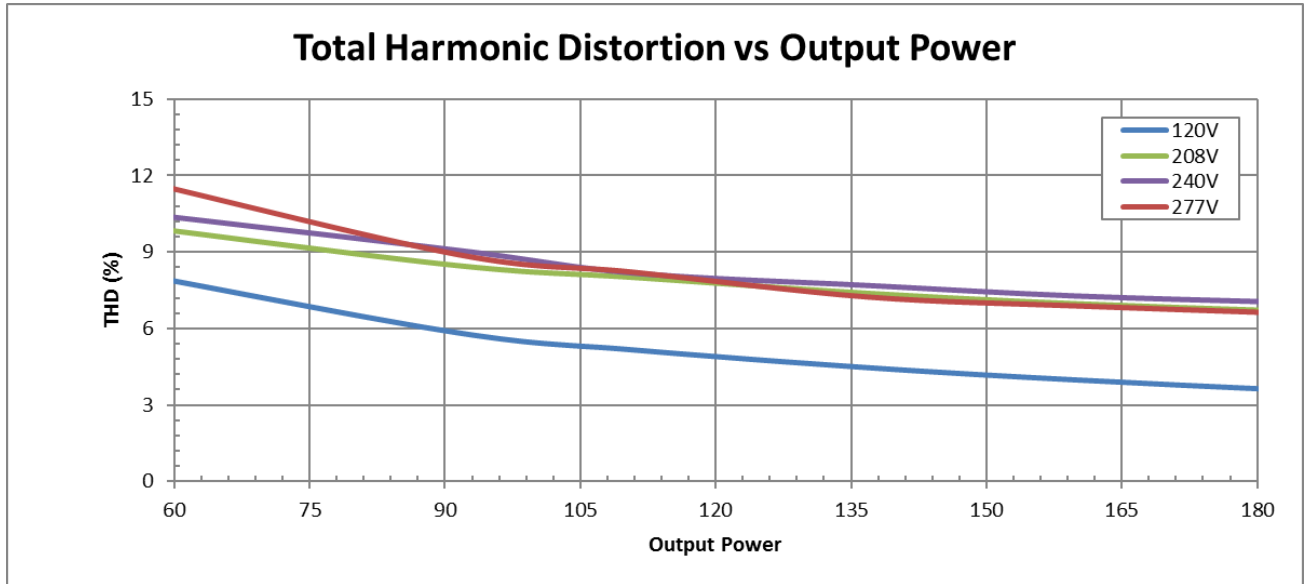

Output power based on maximum rated output current and varying load voltages.



Application and operation performance specification information subject to change without notification.



Transient Protection		
Transient	Differential Mode (L-N)	Common Mode (L-G, N-G, L&N-G)
IEEE C62.41 1.2/50µs Combination Wave (w/t 2Ω)	> 6kV*	> 6kV*

Isolation					
Isolation	Input	Output	0-10V	Auxiliary	Enclosure
Input	-	2xU + 1kV	2xU + 1kV	2xU + 1kV	288V*
Output	2xU + 1kV	-	2xU + 1kV	2xU + 1kV	2xU + 1kV
0-10V	2xU + 1kV	2xU + 1kV	-	2xU + 1kV	2xU + 1kV
Auxiliary	2xU + 1kV	2xU + 1kV	2xU + 1kV	-	2xU + 1kV
Enclosure	288V*	2xU + 1kV	2xU + 1kV	2xU + 1kV	-

U = Max Input Voltage

\*Driver uses MOVs for transient protection.

Refer to application note EVD07 at [www.unvlt.com](http://www.unvlt.com) for additional information on Hi-Pot Testing.

## Driver Lifetime vs. Driver Case Temperature

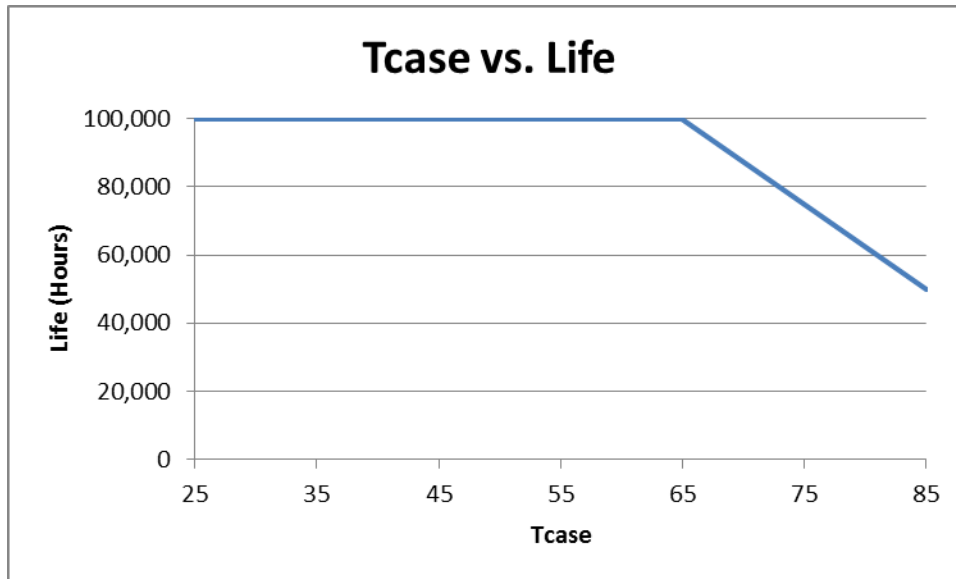

The Data curve provided predicts the LED Driver life based on the case temperature measured at the Tc location identified on the label or specification sheet. The Telecordia SR-332 standard is used to generate the prediction curves.



Application and operation performance specification information subject to change without notification.

Obsolete

# D20CC180UNVPWX24-F

## Dimensional Diagram:

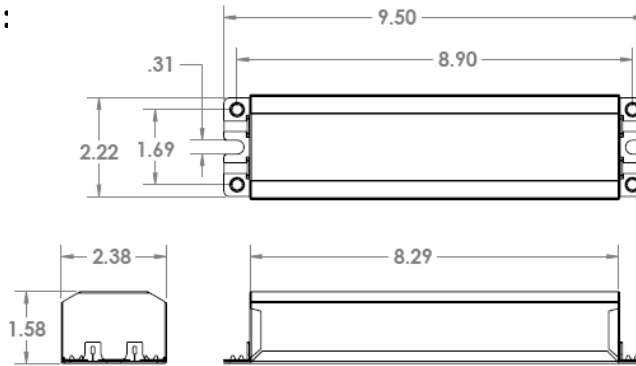

## Tc Location:

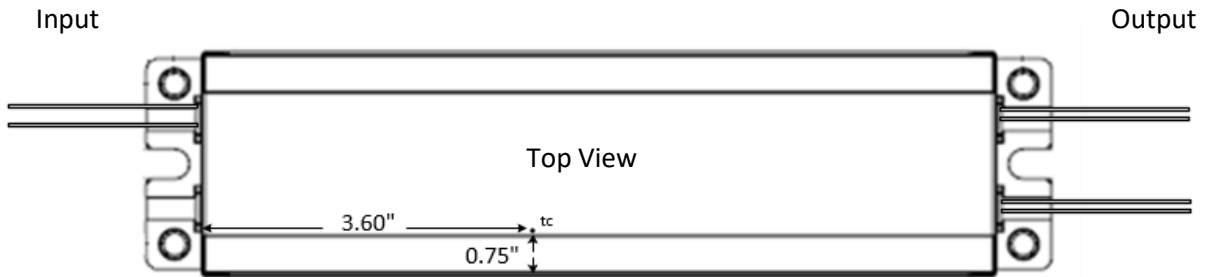

FCC Statement: This device complies with part 15 of the FCC Rules. Operation is subject to the following two conditions: (1) This device may not cause harmful interference, and (2) this device must accept any interference received, including interference that may cause undesired operation.

## Warranty:

Universal Lighting Technologies warrants to the purchaser that each power supply will be free from defects in material or workmanship for a period of 5 years from the date of manufacture when properly installed per instructions and under normal operating conditions of use. Call 1-800-225-5278 for technical assistance.

**EVERLINE**

Application and operation performance specification information subject to change without notification.