

D21CC80UNVPWX24-D

2100mA Programmable LED Driver

- 80W constant current output with 0-10V dimming
- Full featured programmability with 24Vdc 50mA auxiliary output
- Low standby power (<0.5W) in dim-to-off state



Performance	
Input Voltage	120 ~ 277 Vac
Input Current Max	0.77A / 120V 0.33A / 277V
Input Power Max	93W
Input Frequency	50 - 60 (Hz)
Power Factor	> 0.95 @ max load
THD max	< 20 % @ max load
Output Voltage	16V to 38V @ 2.10 Amps (Refer to Driver Operating Range) 16V to 56V @ 1.40 Amps
Max. Output Current	2100mA
Min. Dimming Current	5mA
Output Power	80W
Standby Power	< 0.5W @ 120Vac < 0.5W @ 277Vac
Line Regulation	±3 %
Load Regulation	±5 %
Output Current Ripple	<10% (Pk-Pk/avg)
Inrush Current*	347V: 22A / 436uS Peak / >10% Duration 480V: 54A / 351uS

* source impedance per NEMA 410

Auxiliary Output	
Output Power	1.2W
Output Voltage	24Vdc
Output Current	50 mA

Physical	
Length	16.88 in
Width	1.25 in
Height	1.00 in
Mounting Length	16.28 in
Weight (lbs)	1.25 lbs
Wire Trap / Plug-in Connectors for 16-22 AWG Solid Wire Strip length 0.33 in	

Environmental	
EMI and RFI	Meets FCC part 15 (Class A) Non-Consumer Limits
Sound Rating	Class A
Operating Temperature	-40°C to 55°C (-40°F to 131°F)
Storage Temperature	-40°C to 85°C (-40°F to 185°F)
tc	85°C max for warranty
	90°C max for UL
Location Rating	UL Dry & Damp, Type HL
Transient Protection	IEEE C62.41 2.5kV

Wiring Diagram:

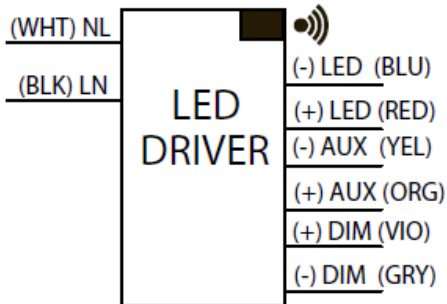

Protection

Over Voltage, Under Voltage, Short Circuit, Over Temp Safety:

UL 8750 & CSA 250.13
UL Class P



Ordering Information

Order Number	Description	Qty/Carton
D21CC80UNVPWX24-D010C	2100mA 80W	10



Application and operation performance specification information subject to change without notification.



Programmable Features
Output Current
Minimum Dimming Level
Dim-to-Off
Dimming Curve (Linear, Linear Soft Start, Logarithmic)
Lumen Maintenance

Programming System	
Software	EVERset Programming Software
Hardware	LDPC000A Configuration Tool
Driver Interface	Wireless via RFID

*Refer to application notes EVD10 and EVD11 at www.unvlt.com for additional information on programmable features.

Driver Operating Range:

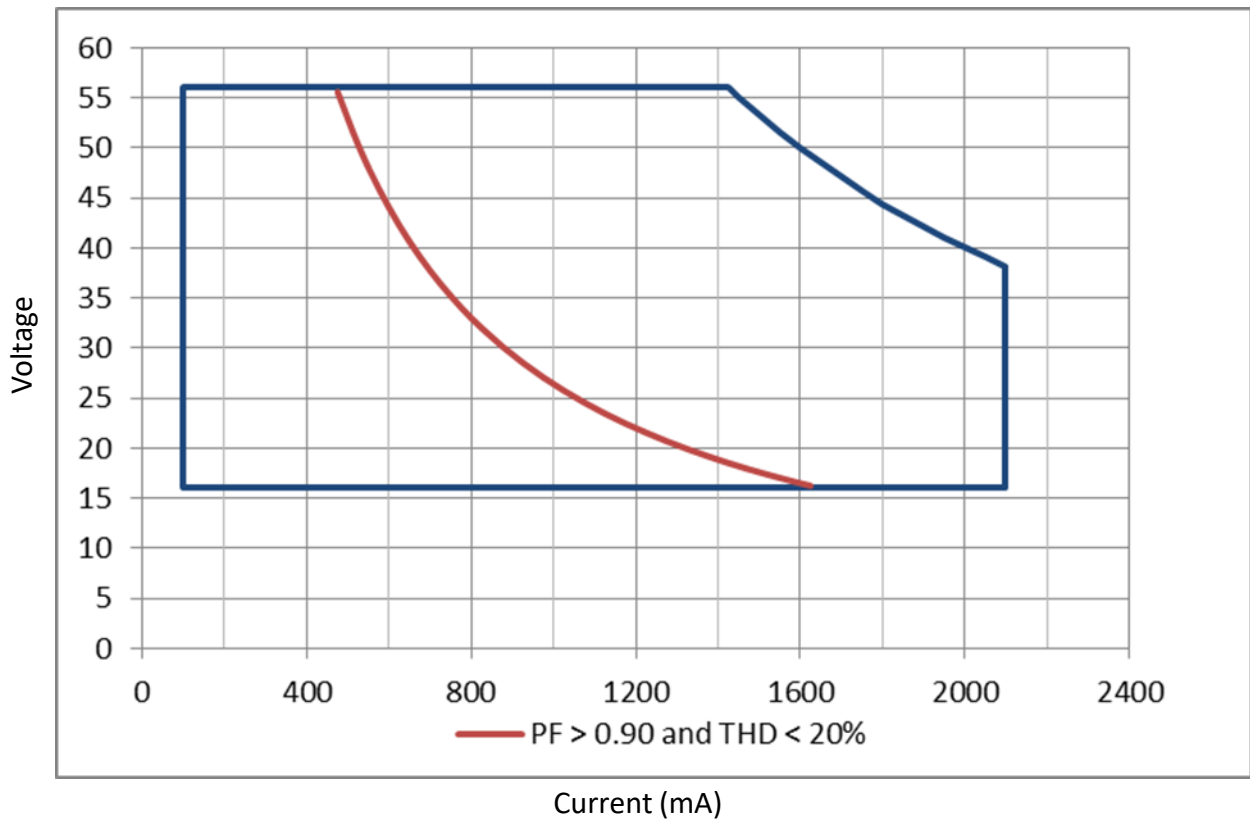

Application and operation performance specification information subject to change without notification.



0-10V Dimming

Linear Dimming w/ Dim-to-Off

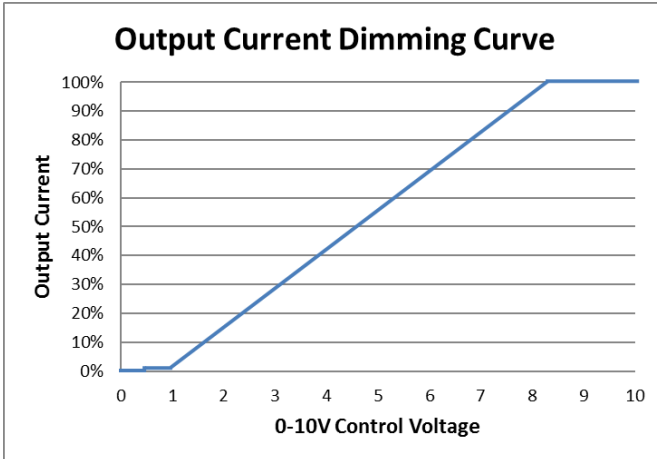

Linear Dimming to 1%*

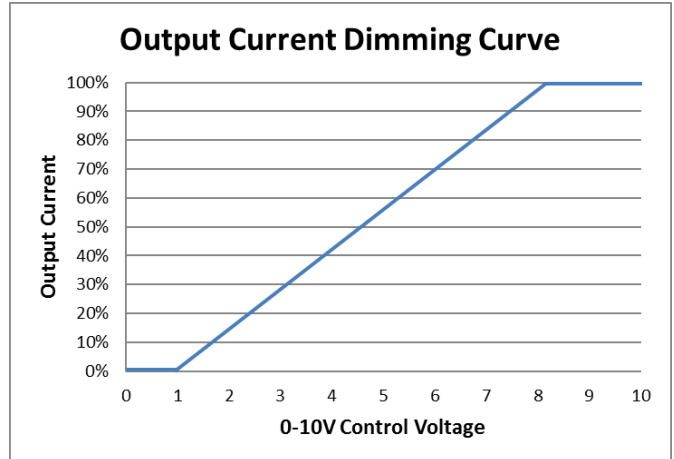

* Driver ships with Dim-to-Off enabled. Dim-to-Off can be disabled through the EVERset programming software.

0-10V Analog Dimming Interface

- Analog 0 to 10 Vdc Voltage Control
- Use Violet (+) & Gray (-) for connection to 0-10 Vdc.
- 10V = maximum output
- 0V = dim-to-off or programmed minimum dimming level
- 0-10V interface can be wired as Class 1 or Class 2 Circuit.
- Driver will source a maximum of 165uA for control needs.
- Controller must sink current from the 0-10V control leads.

Programmable Dimming Features

Feature	Range	Factory Default
Maximum Output Current	100 - 2100mA	default = 2100mA
Minimum Dimming Level	5 - 1050mA	default = 21mA
Dimming Curve	(Linear, Linear Soft Start, Logarithmic w/ factor 1 to 7)	default = Linear
Dimming Control Voltage Range		
Max Bright Control Voltage	7 - 9Vdc	default = 8Vdc
Min Dim Level Control Voltage	1 - 3Vdc	default = 1Vdc
Dim-to-Off	0.1 - 1.7Vdc; 0 = disabled	default = 0Vdc

* Refer to application note EVD10 at www.unvlt.com for additional information on programmable dimming features.



Application and operation performance specification information subject to change without notification.



Performance: Efficiency

Typical performance measurements are shown. The charts are to be used as a guideline and not for specification use.

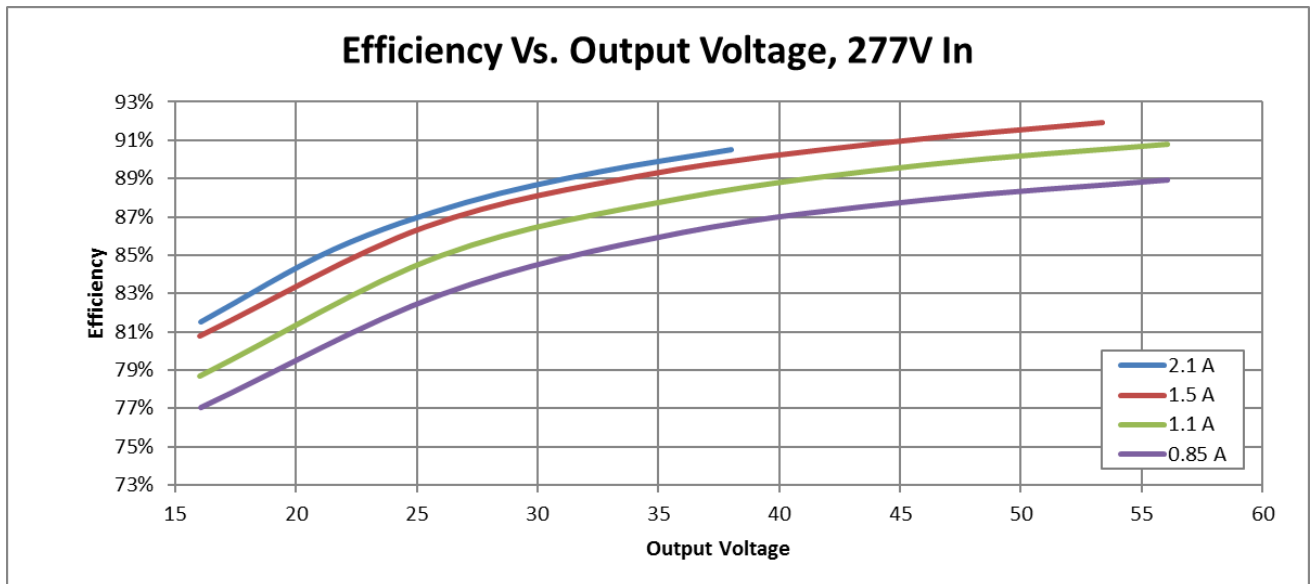
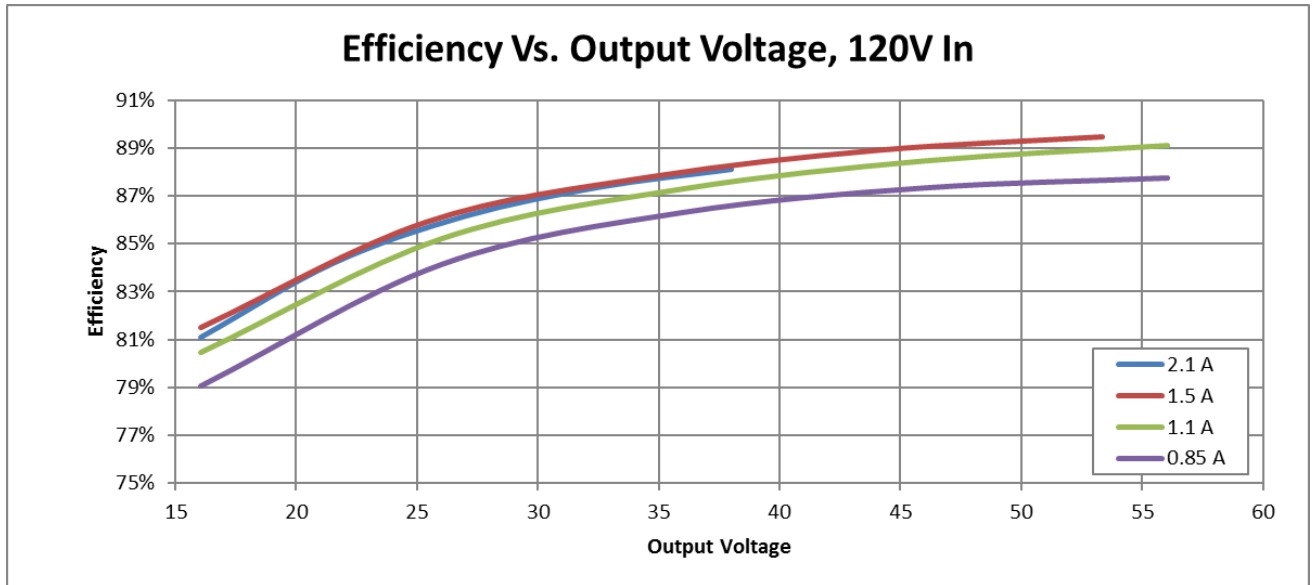

Application and operation performance specification information subject to change without notification.



Performance: Total Harmonic Distortion, & Power Factor

Typical performance measurements are shown. The charts are to be used as a guideline and not for specification use.

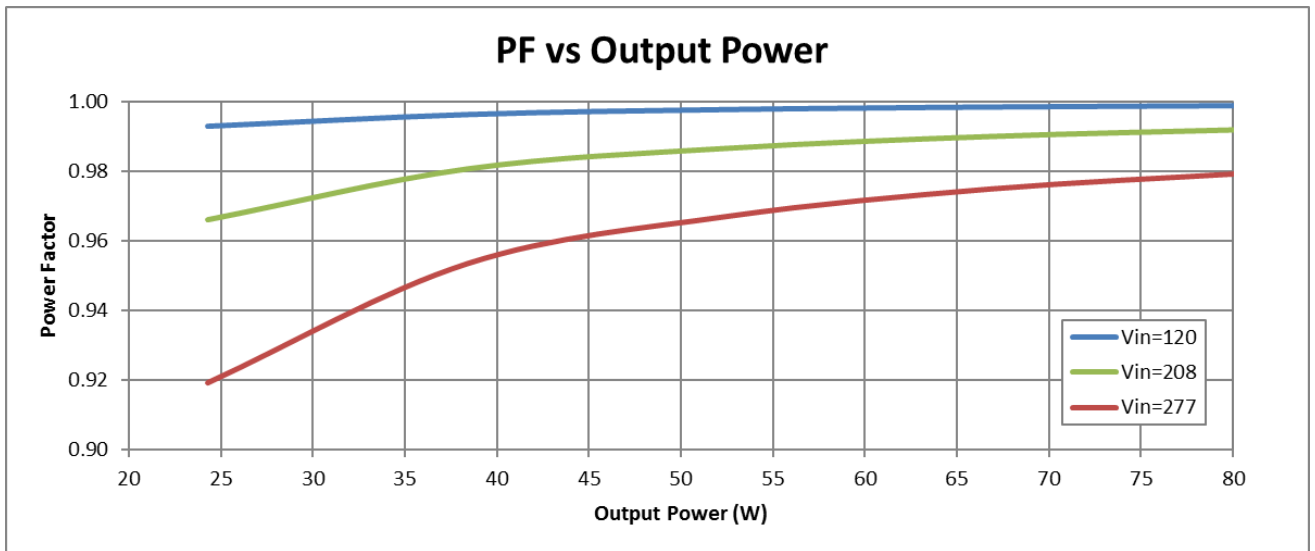
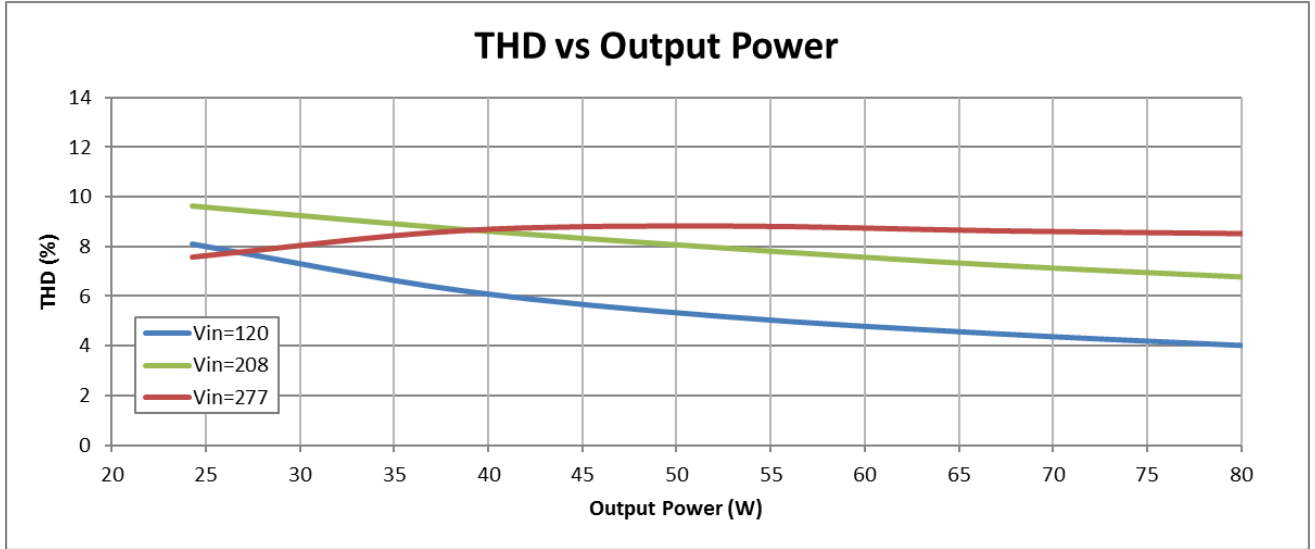

Output power based on maximum rated output current and varying load voltages.



Application and operation performance specification information subject to change without notification.



Transient Protection		
Transient	Differential Mode (L-N)	Common Mode (L-G, N-G, L&N-G)
IEEE C62.41 100kHz Ring Wave (200A maximum)	> 2.5kV	> 2.5kV

Isolation					
Isolation	Input	Output	0-10V	Auxiliary	Enclosure
Input	-	2xU + 1kV	2xU + 1kV	2xU + 1kV	2xU + 1kV
Output	2xU + 1kV	-	2xU + 1kV	Non-Isolated	700V
0-10V	2xU + 1kV	2xU + 1kV	-	2xU + 1kV	2xU + 1kV
Auxiliary	2xU + 1kV	Non-Isolated	2xU + 1kV	-	700V
Enclosure	2xU + 1kV	700V	2xU + 1kV	700V	-

U = Max Input Voltage

Driver Lifetime vs. Driver Case Temperature

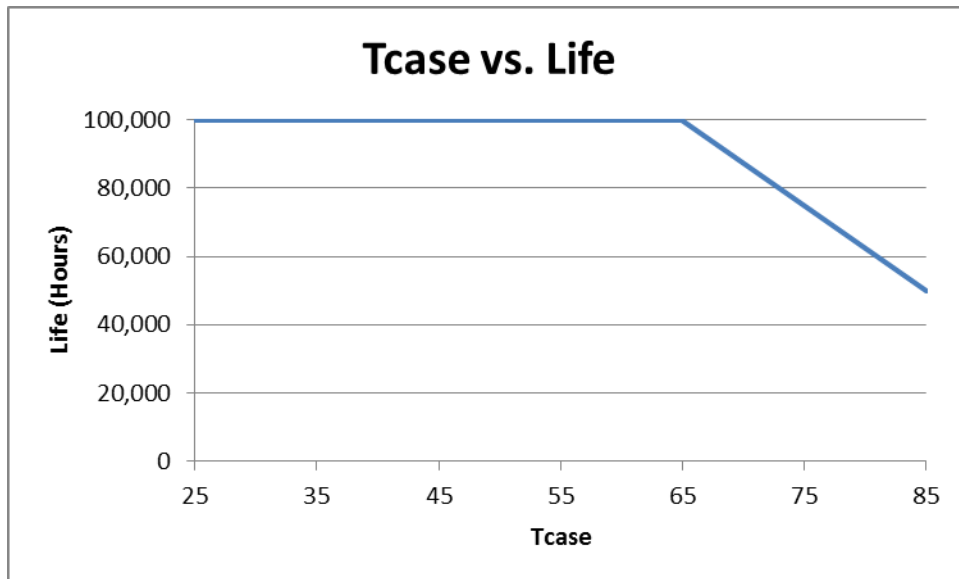

The Data curve provided predicts the LED Driver life based on the case temperature measured at the Tc location identified on the label or specification sheet. The Telecordia SR-332 standard is used to generate the prediction curves.



Application and operation performance specification information subject to change without notification.

Obsolete

D21CC80UNVPWX24-D

Dimensional Diagram:

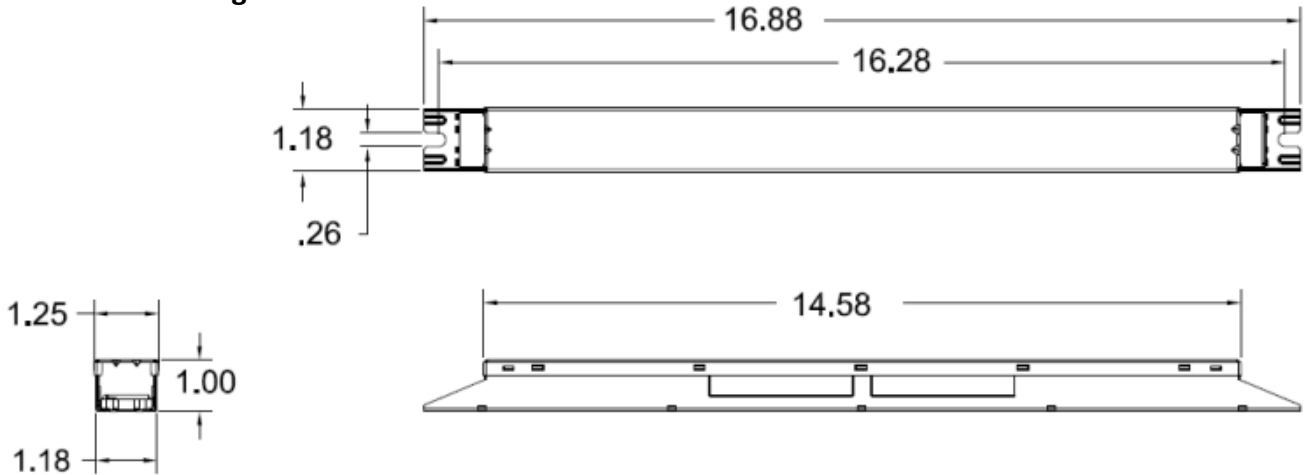

Tc Location:

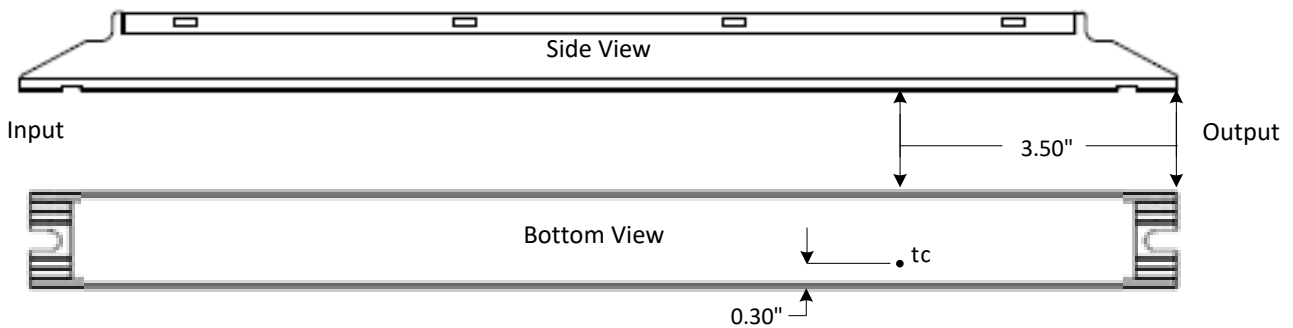

FCC Statement: This device complies with part 15 of the FCC Rules. Operation is subject to the following two conditions: (1) This device may not cause harmful interference, and (2) this device must accept any interference received, including interference that may cause undesired operation.

Warranty:

Universal Lighting Technologies warrants to the purchaser that each power supply will be free from defects in material or workmanship for a period of 5 years from the date of manufacture when properly installed per instructions and under normal operating conditions of use. Call 1-800-225-5278 for technical assistance.

EVERLINE

Application and operation performance specification information subject to change without notification.