

D28CC95UVPA24-VF



2800mA Programmable LED Driver

- Universal (120-277V) Input Voltage
- Class 2, 95W Constant Current Output with 0-10V dimming
- Full featured programmability with 24Vdc 50mA auxiliary output

Performance

Input Voltage	120 ~ 277 Vac
Input Current Max	0.90 /120V 0.39/277V
Input Power Max	108W
Input Frequency	50 - 60 (Hz)
Power Factor*	> 0.95
THD max*	< 20 %
Output Voltage	18V to 34V @ 2.80 Amps (Refer to Power Curve Chart) 18V to 56V @ 1.70 Amps
Max. Output Current	2800mA
Min. Dimming Current	140mA
Output Power	95W
Standby Power	< 2.8W @ 120Vac < 3.5W @ 277Vac
Line Regulation	±3 %
Load Regulation	±5 %
Output Current Ripple	<10% (Pk-Pk/avg)
Inrush Current	120V: 25A / 230uS Peak / >50% Duration 277V: 54A / 85uS

- * Refer to charts for additional information
- Harmonic Emissions comply with ANSI C82.77
 - Inrush current complies with NEMA 410

Ordering Information

Order Number	Description	Qty/Carton
D28CC95UVPA24-VF010C	Standard Product	10

Protection:
Over Voltage, Under Voltage, Short Circuit, Over Temp

Safety:
UL 8750 & CSA 250.13
UL Listed Class P

Auxiliary Output

Output Voltage	24 Vdc
Output Current	50 mA

Physical

Length	5.43 in
Width	3.62 in
Height	1.56 in
Mounting Length	5.16 in
Weight (lbs)	1.4
Lead Lengths (+/- 1 in)	
Blk, Wht, Purple, Gray	11.5 in
Red(+), Blue(-)	11.5 in
Orange, Yellow/Black, Black/Wht, Blue/Wht	11.5 in

Lead-wires are 18 AWG 105°C /600V solid copper.

Environmental

EMI and RFI	Meets FCC part 15 (Class A) Non-Consumer Limits
Operating	-40°C to 55°C
Storage Temperature	-40°C to 85°C
tc	85°C max for warranty 90°C max for UL
Location Rating	UL Dry & Damp, Type HL
Transient Protection	IEEE C62.41 6kV**

**Driver uses MOVs for transient protection.
Refer to application note EVD07 at www.unvlt.com for additional information on Hi-Pot Testing.



Application and operation performance specification information subject to change without notification.



Programmable Features
Output Current
Minimum Dimming Level
Dim-to-Off
Dimming Curve (Linear, Linear Soft Start, Logarithmic)
Lumen Maintenance

Programming System	
Software	EVERset Programming Software
Hardware	LDPC000A Configuration Tool
Driver Interface	Wired via 0-10V leads

*Refer to application notes EVD10 and EVD11 at www.unvlt.com for additional information on programmable features.

Wiring Diagram

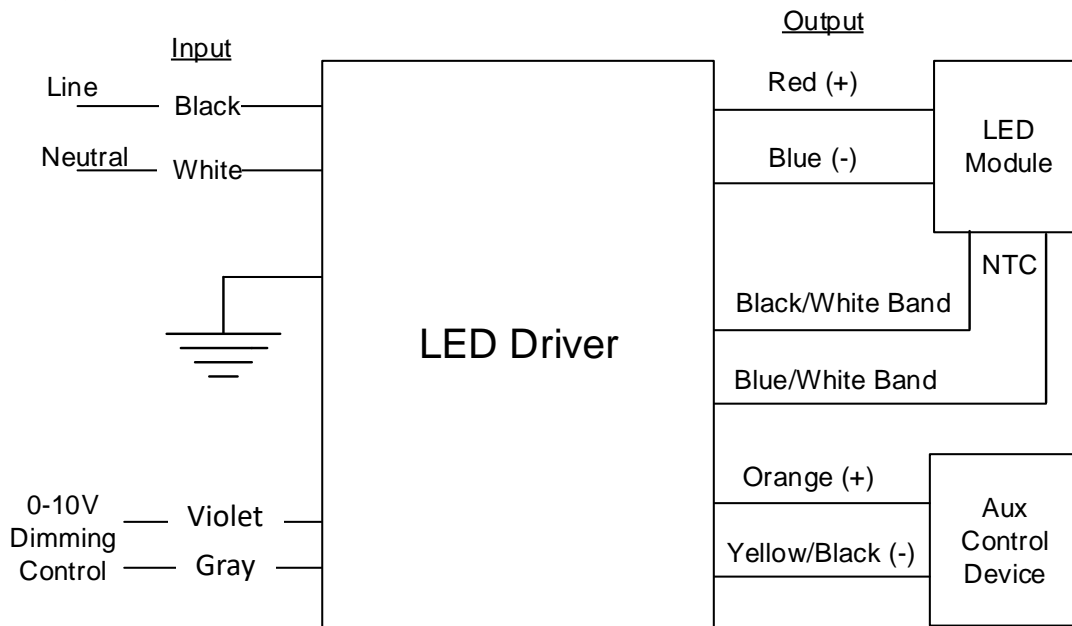

- **NOTE:** Unused Black/White and Blue/White leads must be individually capped off when thermal foldback control is not used.
- **NOTE:** Unused Orange and Yellow/Black leads must be individually capped off when auxiliary output power is not used.



Application and operation performance specification information subject to change without notification.



Driver Operating Range:

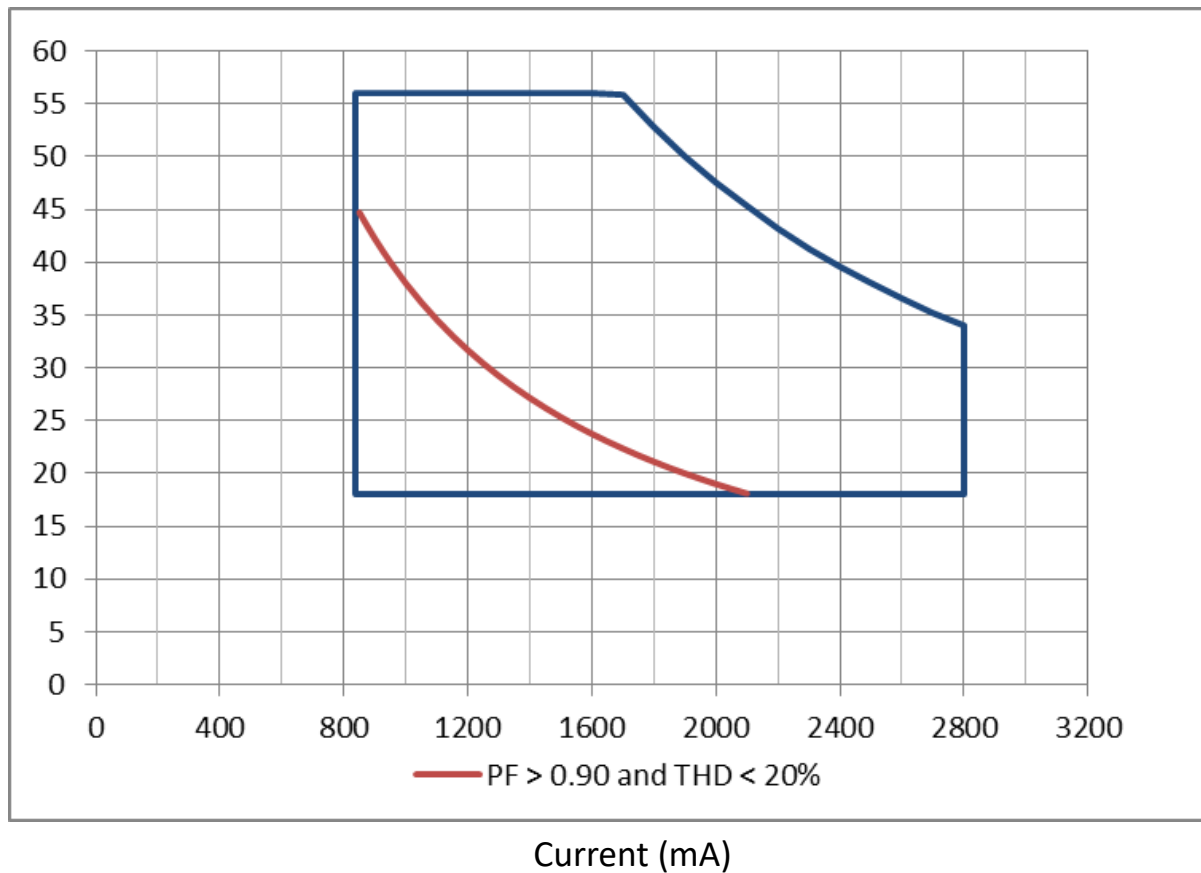

Application and operation performance specification information subject to change without notification.



0-10V Dimming

Linear Dimming to 5%

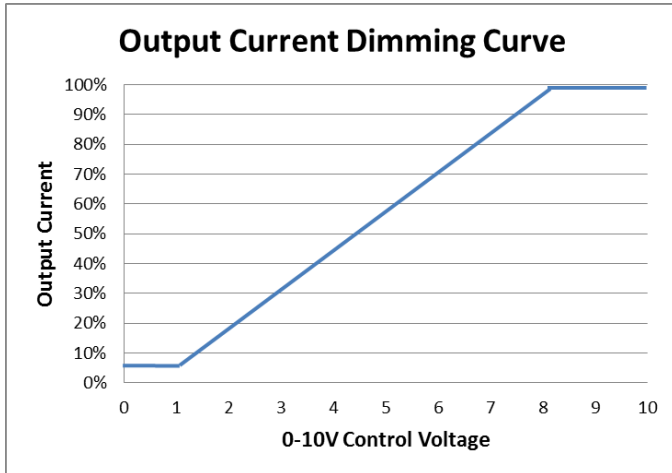

Linear Dimming w/ Dim-to-Off

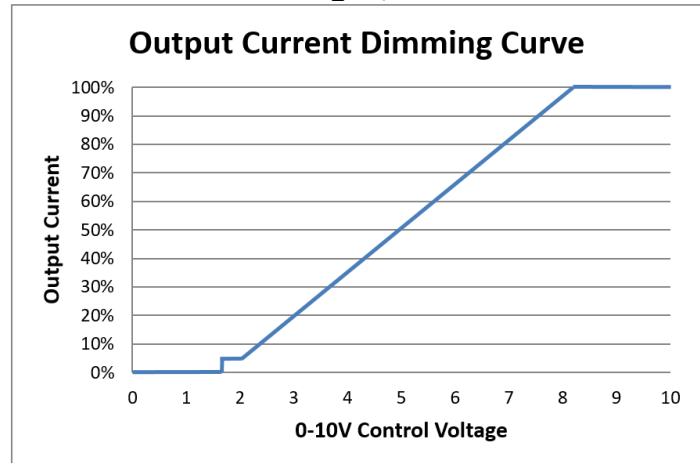

* Driver ships with Dim-to-Off disabled. Dim-to-Off must be enabled through the EVERset programming software.

0-10V Analog Dimming Interface

- Analog 0 to 10 vDC Voltage Control
- Use Violet (+) & Gray (-) for connection to 0-10vDC.
- 10v = maximum output, 0v = minimum output
- Wiring Violet & Gray together provides min. light output.
- Capping Violet & Gray separately provides 100% light output.
- 0-10V interface can be wired as Class 1 or Class 2 Circuit.
- Driver will source a maximum of 165uA for control needs.
- Controller must sink current from the 0-10V control leads.

Programmable Dimming Features

Feature	Range	Factory Default
Maximum Output Current	840 - 2800mA	default = 2800mA
Minimum Dimming Level	140 - 700mA	default = 140mA
Dimming Curve	(Linear, Linear Soft Start, Logarithmic w/ factor 1 to 7)	default = Linear
Dimming Control Voltage Range		
Max Bright Control Voltage	7 - 9Vdc	default = 8Vdc
Min Dim Level Control Voltage	1 - 3Vdc	default = 1Vdc
Dim-to-Off	0.1 - 1.7Vdc	default = 0Vdc (disabled)

* Refer to application note EVD10 at www.unvlt.com for additional information on programmable dimming features.



Application and operation performance specification information subject to change without notification.



Performance: Efficiency

Typical performance measurements are shown. The charts are to be used as a guideline and not for specification use.

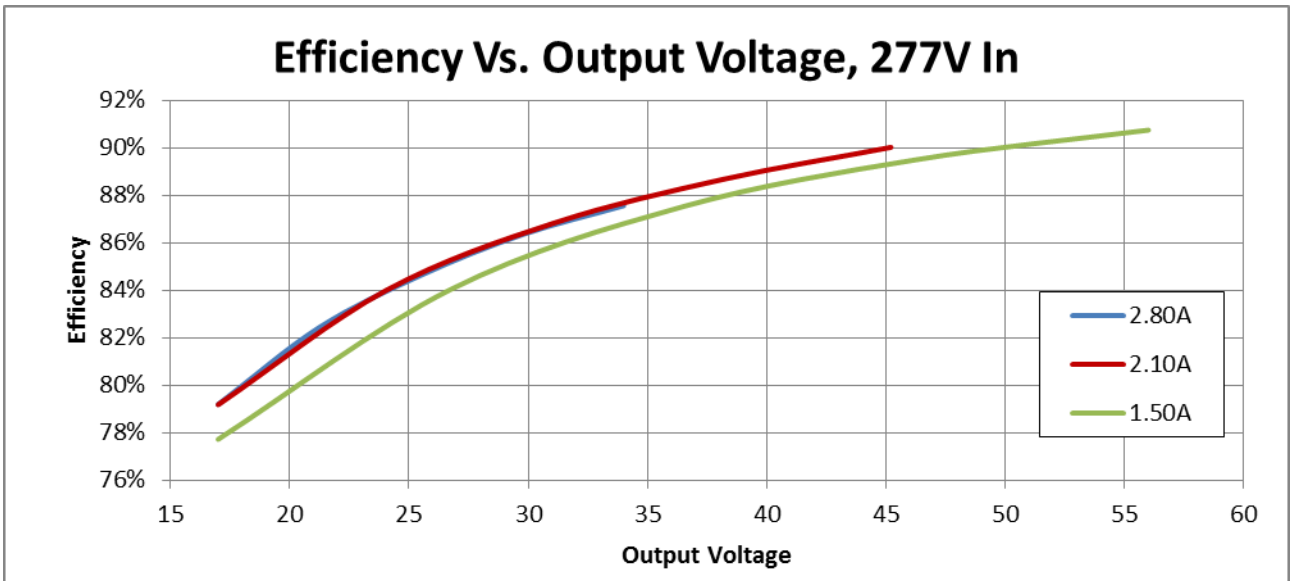
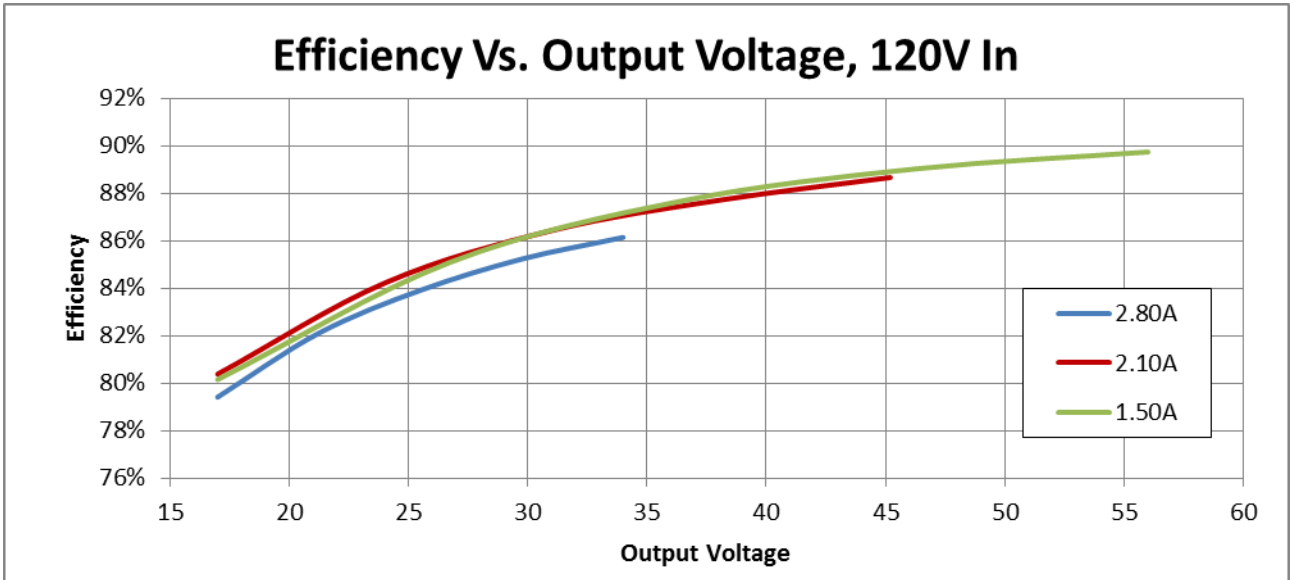

Application and operation performance specification information subject to change without notification.



Performance: Total Harmonic Distortion, & Power Factor

Typical performance measurements are shown. The charts are to be used as a guideline and not for specification use.

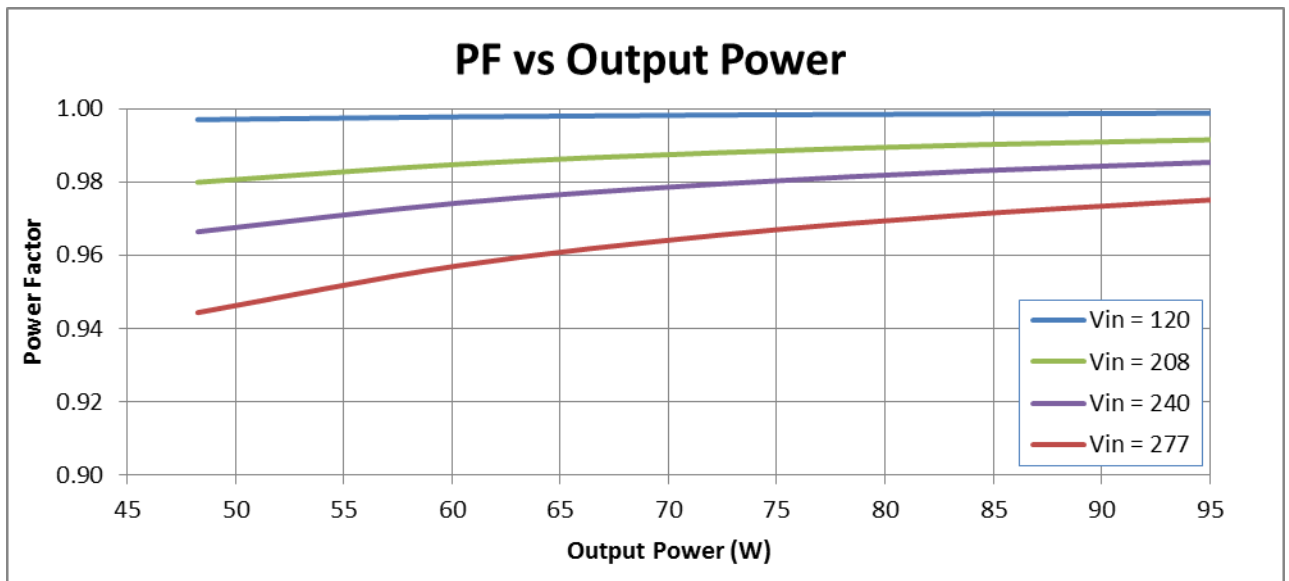
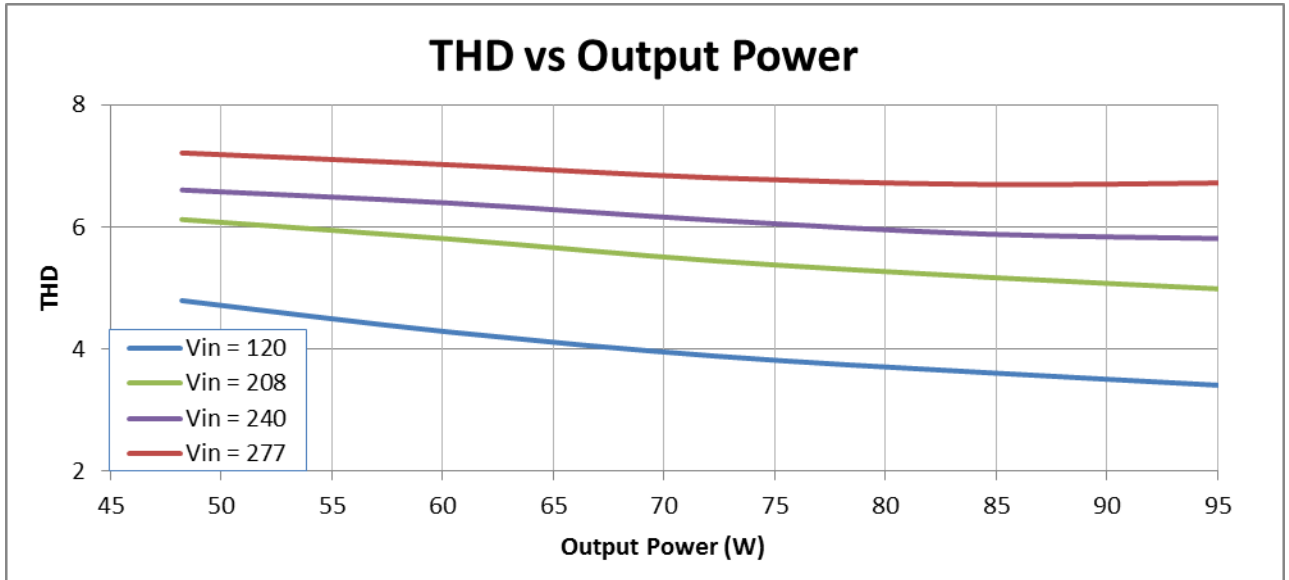

Output power based on maximum rated output current and varying load voltages.



Application and operation performance specification information subject to change without notification.



Module Thermal Foldback Protection

Thermal Foldback Control

- Luminaire temperature monitoring/protection
- LED Driver reduces output current for external thermal protection if an NTC (Negative Thermal Coefficient) is connected to the Black/White and Blue/White leads.
- **NOTE:** Unused Black/White and Blue/White leads must be individually capped off when thermal foldback control is not used.
- See application note EVD02 on www.unvlt.com for more information.

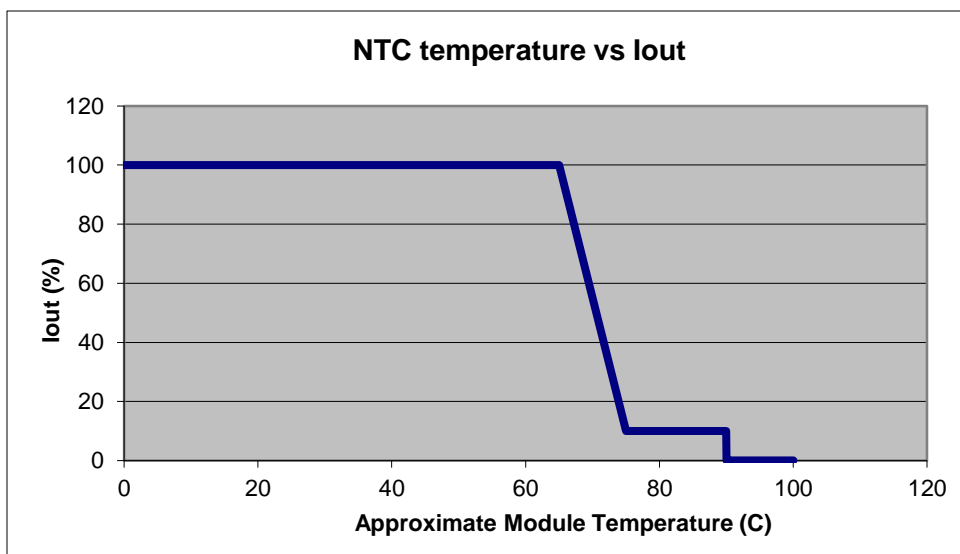

(Example with the Murata NTC p/n NCP18XV103J03RB)



Application and operation performance specification information subject to change without notification.



Transient Protection		
Transient	Differential Mode (L-N)	Common Mode (L-G, N-G, L&N-G)
IEEE C62.41 1.2/50µs Combination Wave (w/t 2Ω)	> 6kV**	> 6kV**

**Driver uses MOVs for transient protection.

Refer to application note EVD07 at www.unvlt.com for additional information on Hi-Pot Testing.

Isolation						
Isolation	Input	Output	0-10V	Auxiliary	NTC	Enclosure
Input	-	2xU + 1kV	2xU + 1kV	2xU + 1kV	2xU + 1kV	410V
Output	2xU + 1kV	-	2xU + 1kV	Non-isolated	Non-isolated	700V
0-10V	2xU + 1kV	2xU + 1kV	-	2xU + 1kV	2xU + 1kV	2xU + 1kV
Auxiliary	2xU + 1kV	Non-isolated	2xU + 1kV	-	Non-isolated	700V
NTC	2xU + 1kV	Non-isolated	2xU + 1kV	Non-isolated	-	2xU + 1kV
Enclosure	410V	700V	2xU + 1kV	700V	2xU + 1kV	-

U = Max Input Voltage

Life vs. Driver Tcase

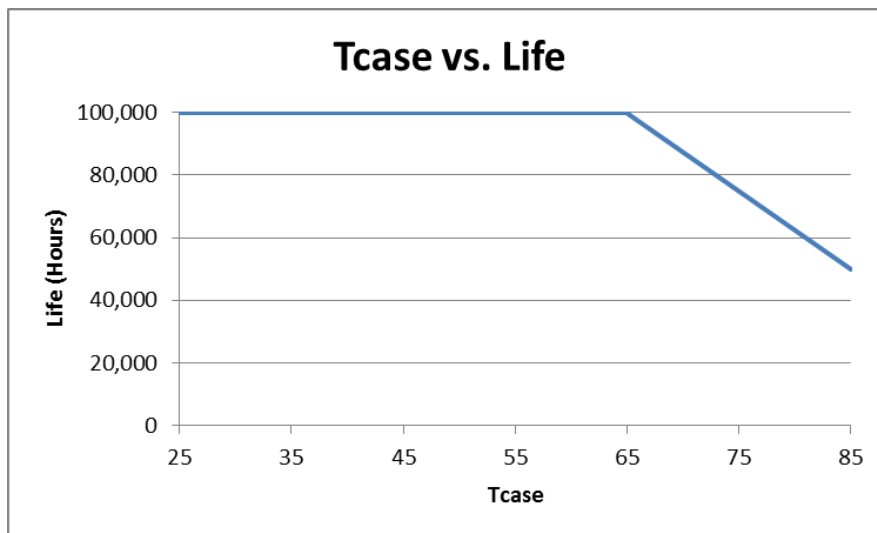

The Data curve provided predicts the LED Driver life based on the case temperature measured at the Tc location identified on the label or specification sheet. The Telecordia SR-332 standard is used to generate the prediction curves.



Application and operation performance specification information subject to change without notification.



Dimensional Diagram

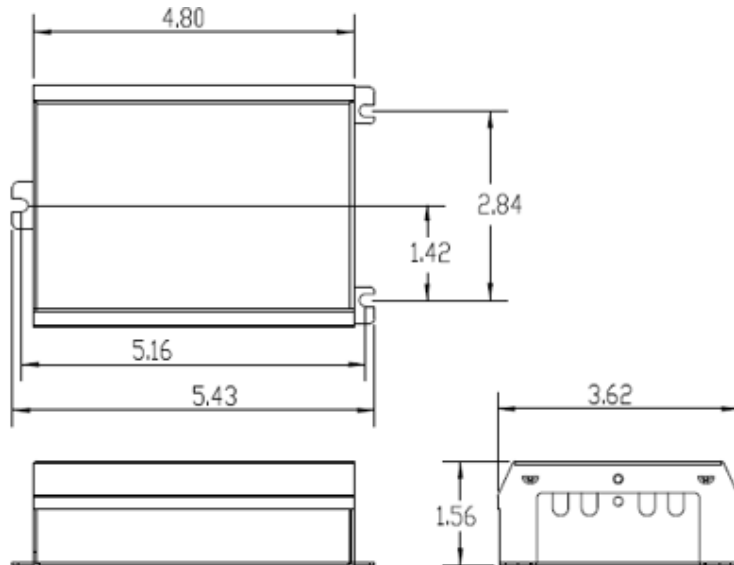

Tc Location

Input/Output
Side

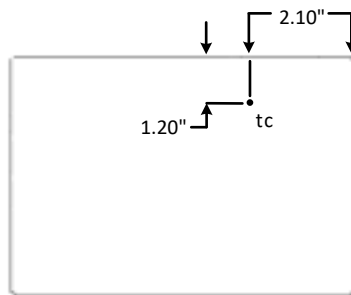

Bottom View

FCC Statement: This device complies with part 15 of the FCC Rules. Operation is subject to the following two conditions: (1) This device may not cause harmful interference, and (2) this device must accept any interference received, including interference that may cause undesired operation.

Warranty:

Universal Lighting Technologies warrants to the purchaser that each power supply will be free from defects in material or workmanship for a period of 5 years from the date of manufacture when properly installed per instructions and under normal operating conditions of use. Call 1-800-225-5278 for technical assistance.



Application and operation performance specification information subject to change without notification.