

# D700C150UV10F

## 700mA LED Driver

- Universal Input Voltage 120 – 277 Vac
- 0-10V Dimming to 10%
- Thermal Foldback Control



### Performance

Input Voltage	120 ~ 277 Vac
Input Current Max	1.40 /120V 0.59/277V
Input Power Max	165W /120V 161W/277V
Input Frequency	50 - 60 (Hz)
Power Factor	> 0.95
THD max	< 20 %
Output Voltage	75V-215V
Output Current	70-700mA
Output Power	150W Max
Line Regulation	±1 %
Load Regulation	±3 %
Output Current Ripple	<10%
Inrush Current	120V: 31A / 210uS
Peak / >50% Duration	277V: 74A / 200uS

- \* Refer to charts for additional information
- Harmonic Emissions comply with ANSI C82.77
- Inrush current complies with NEMA 410

### Environmental

EMI and RFI	Meets FCC part 15 (Class A) Non-Consumer Limits
Minimum Operating Temperature	-40°C (-40°F)
Storage Temperature	-40°C to 85°C (-40°F to 185°F)
tc	85°C (185°F) max
Location Rating	UL Dry & Damp, Type HL
Transient Protection	IEEE C62.41 6kV**

\*\*Driver uses MOVs for transient protection.  
Refer to application note EVD07 at [www.unvlt.com](http://www.unvlt.com) for additional information on Hi-Pot Testing.

### Physical

Length	9.50 in (241.3 mm)
Width	2.40 in (61.0 mm)
Height	1.55 in (39.4 mm)
Mounting Length	8.89 in (225.8 mm)
Weight (lbs)	2.6
Lead Lengths	
Blk, Wht, Blk/Wht, Blu/Wht	11.5 +/- 1.0 in
Red(+), Blue(-), Gry, Prp	11.5 +/- 1.0 in

Lead-wires are 18 AWG 105°C /600V solid copper.

### Protection

Over voltage, Overload and short circuit, over temp.

### Safety:

UL 8750 & CSA 250.13  
UL Class P

### Ordering Information

Order Number	Description	Qty/Carton
D700C150UV10F20KC	Standard Product	10
D700C150UV10FR00C	Rated IP66	10

### Wiring Diagram:

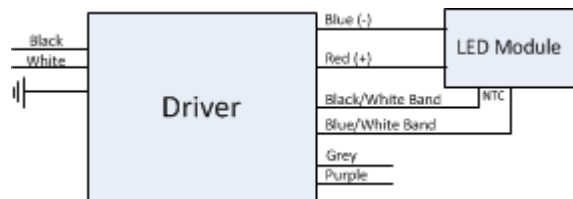

- **NOTE:** Unused Black/White and Blue/White leads must be individually capped off when thermal foldback control is not used.



Application and operation performance specification information subject to change without notification.



## 0-10V Dimming

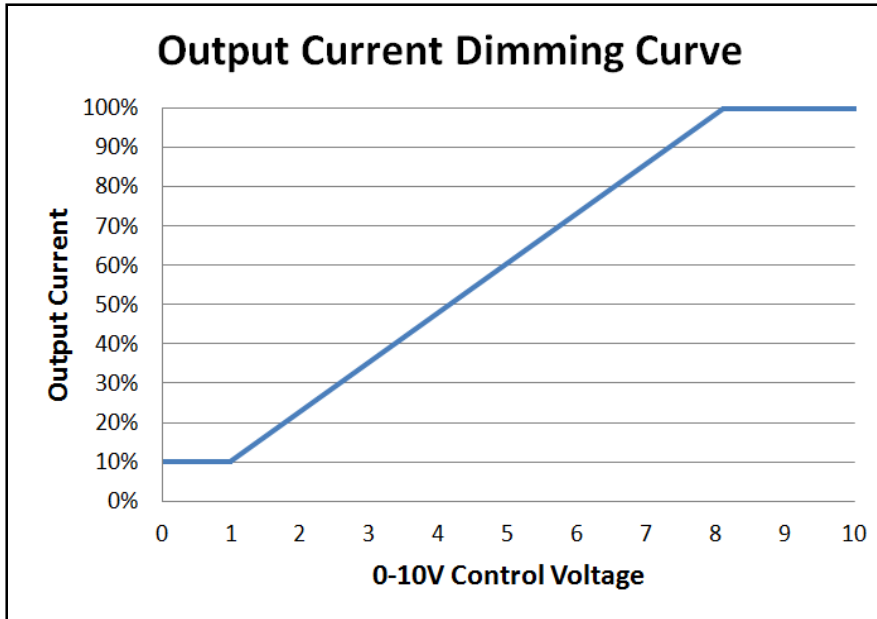

### 0-10V Analog Dimming Interface

- Analog 0 to 10 vDC Voltage Control
- Use Violet (+) & Gray (-) for connection to 0-10vDC.
- 10v = maximum output, 0v = minimum output
- Wiring Violet & Gray together provides min. light output.
- Capping Violet & Gray separately provides 100% light output.
- 0-10V interface can be wired as Class 1 or Class 2 Circuit.
- Driver will source a maximum of 200uA for control needs.
- Controller must sink current from the 0-10V control leads.



Application and operation performance specification information subject to change without notification.



## Performance: Efficiency, THD, & Power Factor

Typical performance measurements are shown. The charts are to be used as a guideline and not for specification use.

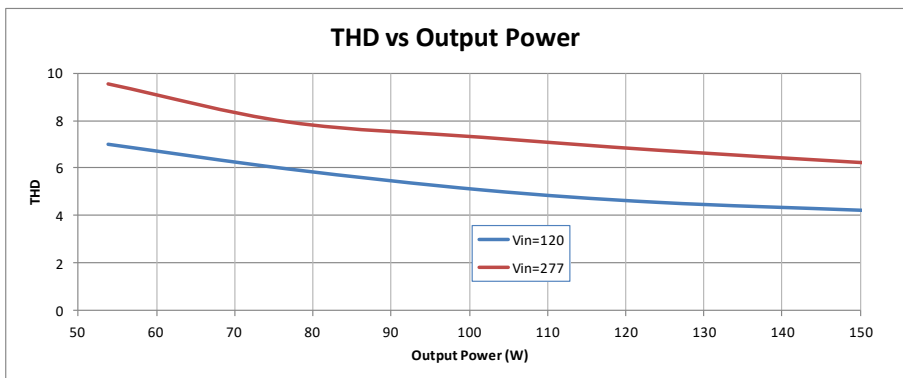
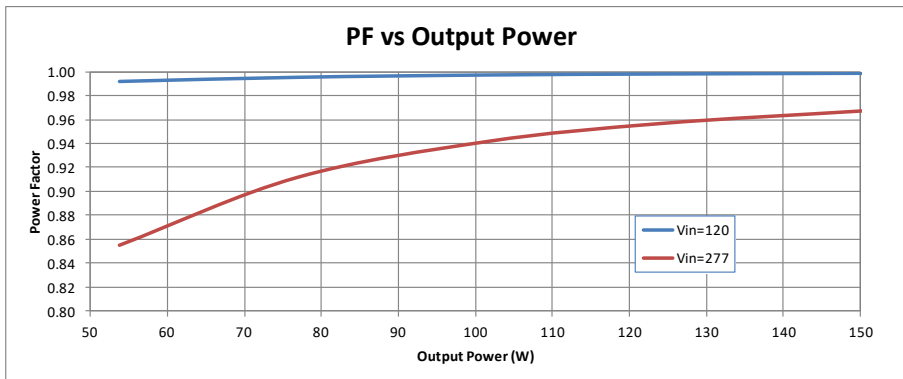
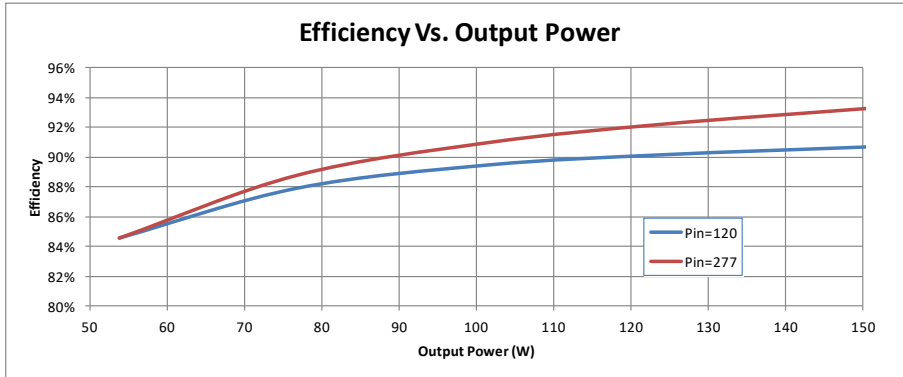

Output power based on maximum rated output current and varying load voltages.



Application and operation performance specification information subject to change without notification.



## Module Thermal Foldback Protection

### Thermal Foldback Control

- Luminaire temperature monitoring/protection
- LED Driver reduces output current for external thermal protection if an NTC (Negative Thermal Coefficient) is connected to the Black/White and Blue/White leads.
- **NOTE:** Unused Black/White and Blue/White leads must be individually capped off when thermal foldback control is not used.
- See application note on [www.unvlt.com](http://www.unvlt.com) for more information.

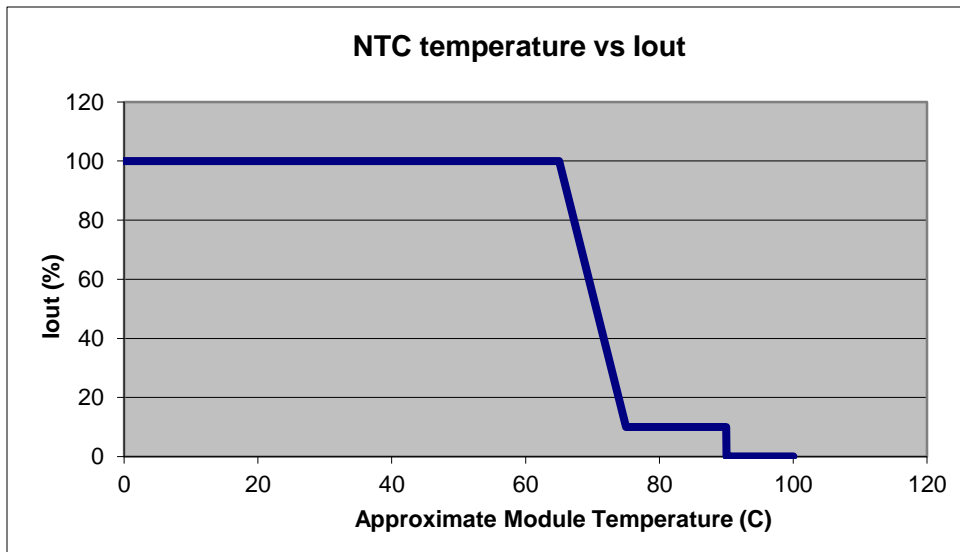

(Example with the Murata NTC p/n NCP18XV103J03RB)



Application and operation performance specification information subject to change without notification.



## Life Rating Prediction

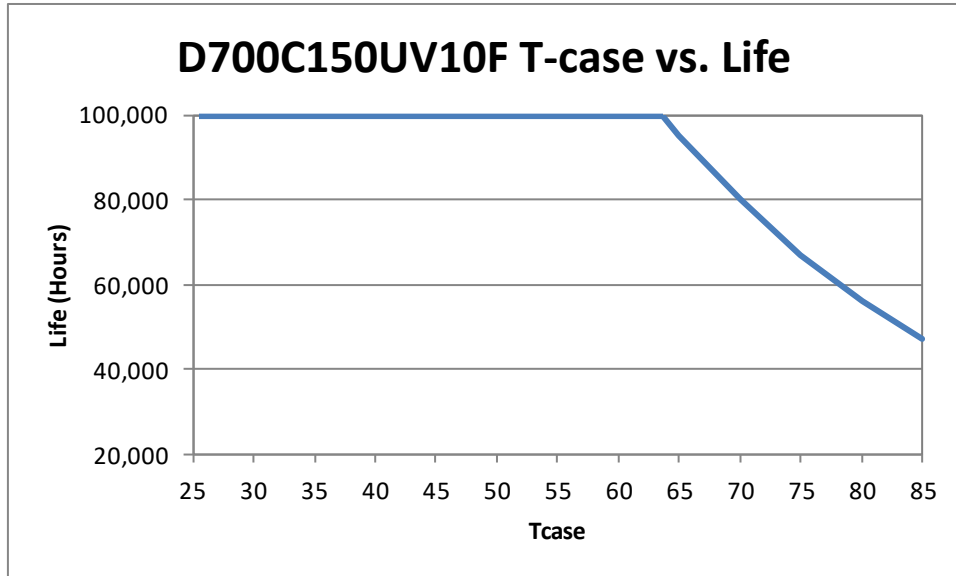

The Data curve provided predicts the LED Driver life based on the case temperature measured at the Tc location identified on the label or specification sheet. The Telecordia SR-332 standard is used to generate the prediction curves.

## Dimensional Diagram

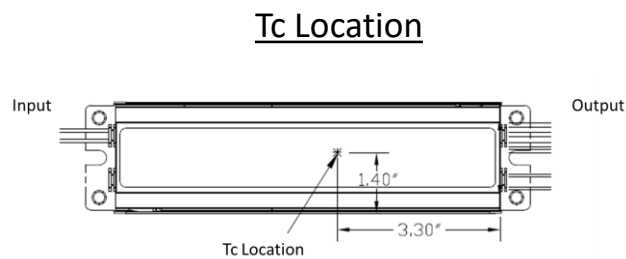
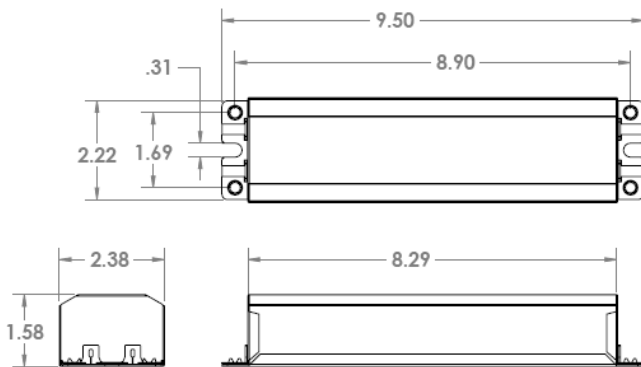

### Warranty:

Universal Lighting Technologies warrants to the purchaser that each power supply will be free from defects in material or workmanship for a period of 5 years from the date of manufacture when properly installed per instructions and under normal operating conditions of use. Call 1-800-225-5278 for technical assistance.



Application and operation performance specification information subject to change without notification.