



## 700mA LED Driver w/ Tuning

- Universal Input Voltage 120 – 277 Vac
- 0-10V Dimming to 10%
- Thermal Foldback Control

### Performance

Input Voltage	120 ~ 277 Vac
Input Current Max	1.40 /120V 0.59/277V
Input Power Max	165W /120V 161W/277V
Input Frequency	50 - 60 (Hz)
Power Factor	> 0.95
THD max	< 20 %
Output Voltage	75V-215V
Output Current	70-700mA
Output Power	150W Max
Line Regulation	±1 %
Load Regulation	±3 %
Output Current Ripple	<10%
Inrush Current	120V: 31A / 210uS
Peak / >50% Duration	277V: 74A / 200uS

- \* Refer to charts for additional information
- Harmonic Emissions comply with ANSI C82.77
- Inrush current complies with NEMA 410

### Environmental

EMI and RFI	Meets FCC part 15 (Class A) Non-Consumer Limits
Minimum Operating Temperature	-40°C (-40°F)
Storage Temperature	-40°C to 85°C
tc	(-40°F to 185°F)
Location Rating	85°C (185°F) max
Location Rating	UL Dry & Damp, Type HL
Transient Protection	IEEE C62.41 6kV**

\*\*Driver uses MOVs for transient protection. Refer to application note EVD07 at [www.universaldouglas.com](http://www.universaldouglas.com) for additional information on Hi-Pot Testing.

### Physical

Length	9.50 in (241.3 mm)
Width	2.40 in (61.0 mm)
Height	1.55 in (39.4 mm)
Mounting Length	8.89 in (225.8 mm)
Weight (lbs)	2.6
Lead Lengths	
Blk, Wht, Blk/Wht, Blu/Wht	11.5 +/- 1.0 in
Red(+), Blue(-), Pnk*, Prp	11.5 +/- 1.0 in

Lead-wires are 18 AWG 105°C /600V solid copper.

### Protection

Over voltage, Overload and short circuit, over temp.

### Safety:

UL 8750 & CSA 250.13  
UL Class P

### Ordering Information

Order Number	Description	Qty/Carton
D700C150UVT-F20KC	Standard Product	10
D700C150UVT-FR00C	Rated IP66	10

\*Consult Factory for Tuning ordering information

### Wiring Diagram:

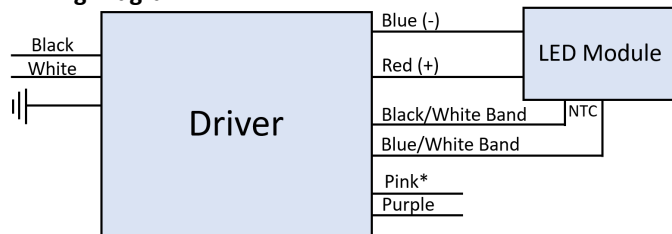

- **NOTE:** Unused Black/White and Blue/White leads must be individually capped off when thermal foldback control is not used.
- \* **Note:** The Gray has been changed to Pink for the negative 0-10V dimming control lead.



Application and operation performance specification information subject to change without notification.

## Programmable Tuned Output Settings

- This Universal Douglas LED Driver can be configured to set its current output to a selected fraction of their maximum rated design level. This function is called tuning (or also high-end trim) and it can be implemented with the LDTC01A using the Selector rotary switches. Tuning assignments are stored in driver memory and are not lost when power is removed. All factory produced drivers are tuned to maximum output unless otherwise noted on the label.
- Tuning SET Levels are listed in the table to the right. The SET Level corresponds to an associated Output Current value.
- Tuned output tolerance of  $\pm 5\%$ .
- Refer to application note EVD06 at [www.universaldouglas.com](http://www.universaldouglas.com) for additional information.

Set Value	Output Current (A)
100	0.700
99	0.690
98	0.680
97	0.670
96	0.661
95	0.651
94	0.641
93	0.632
92	0.623
91	0.613
90	0.604
89	0.595
88	0.586
87	0.577
86	0.568
85	0.560
84	0.551
83	0.542
82	0.534
81	0.525

Set Value	Output Current (A)
80	0.517
79	0.509
78	0.501
77	0.493
76	0.484
75	0.476
74	0.469
73	0.461
72	0.453
71	0.445
70	0.438
69	0.430
68	0.422
67	0.415
66	0.407
65	0.400
64	0.393
63	0.385
62	0.378
61	0.371

Set Value	Output Current (A)
60	0.364
59	0.357
58	0.350
57	0.343
56	0.336
55	0.329
54	0.322
53	0.315
52	0.308
51	0.301
50	0.295
49	0.288
48	0.281
47	0.275
46	0.268
45	0.261
44	0.255
43	0.248
42	0.242
41	0.235
40	0.229

Application and operation performance specification information subject to change without notification.

## 0-10V Dimming

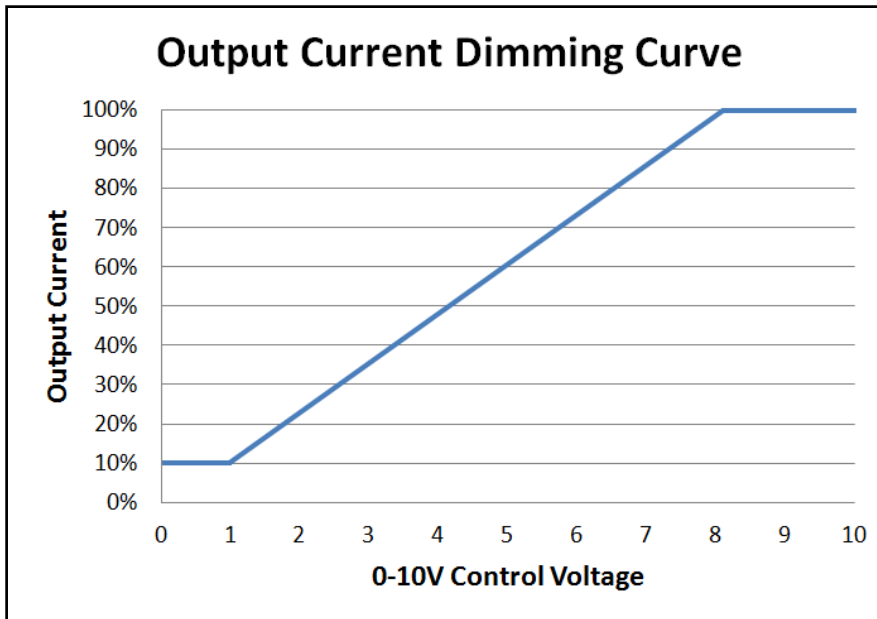

### 0-10V Analog Dimming Interface

- Analog 0 to 10 vDC Voltage Control
- Use Violet (+) & Pink\* (-) for connection to 0-10vDC.
- 10v = maximum output, 0v = minimum output
- Wiring Violet & Pink\* together provides min. light output.
- Capping Violet & Pink\* separately provides 100% light output.
- 0-10V interface can be wired as Class 1 or Class 2 Circuit.
- Driver will source a maximum of 200uA for control needs.
- Controller must sink current from the 0-10V control leads.

Application and operation performance specification information subject to change without notification.

## Performance: Efficiency, THD, & Power Factor

Typical performance measurements are shown. The charts are to be used as a guideline and not for specification use.

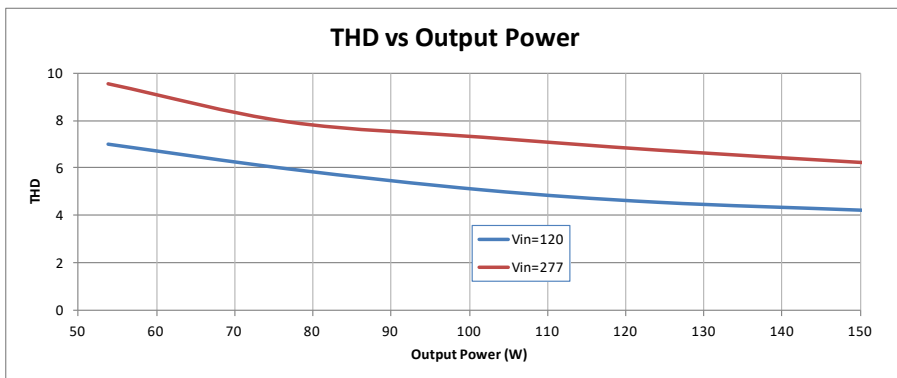
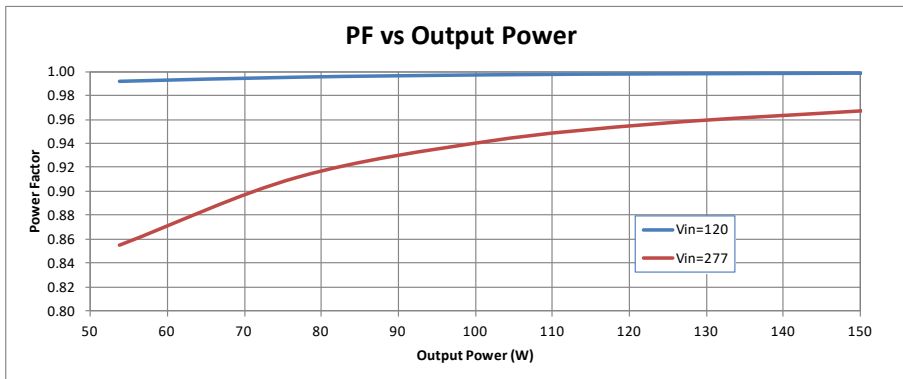
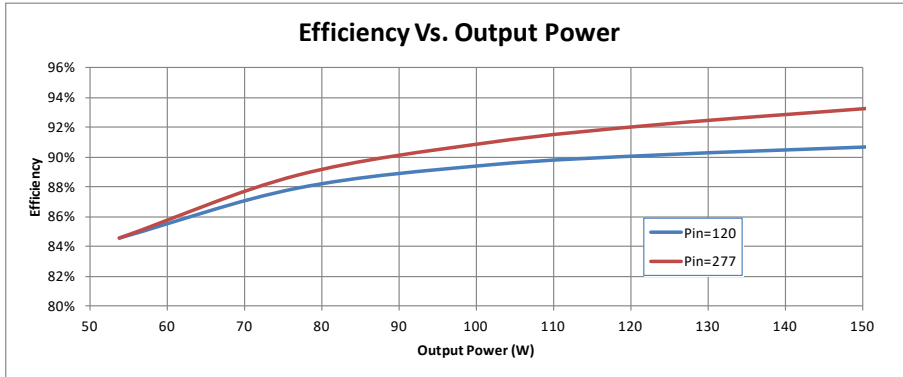

Output power based on maximum rated output current and varying load voltages.

Application and operation performance specification information subject to change without notification.

## Module Thermal Foldback Protection

### Thermal Foldback Control

- Luminaire temperature monitoring/protection
- LED Driver reduces output current for external thermal protection if an NTC (Negative Thermal Coefficient) is connected to the Black/White and Blue/White leads.
- **NOTE:** Unused Black/White and Blue/White leads must be individually capped off when thermal foldback control is not used.
- See application note on [www.universaldouglas.com](http://www.universaldouglas.com) for more information.

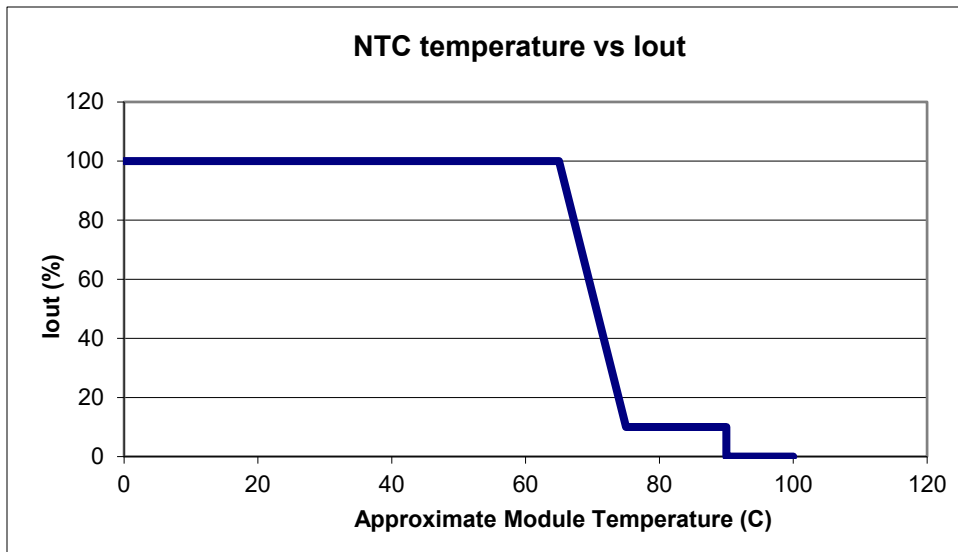

(Example with the Murata NTC p/n NCP18XV103J03RB)

Application and operation performance specification information subject to change without notification.

## Life Rating Prediction

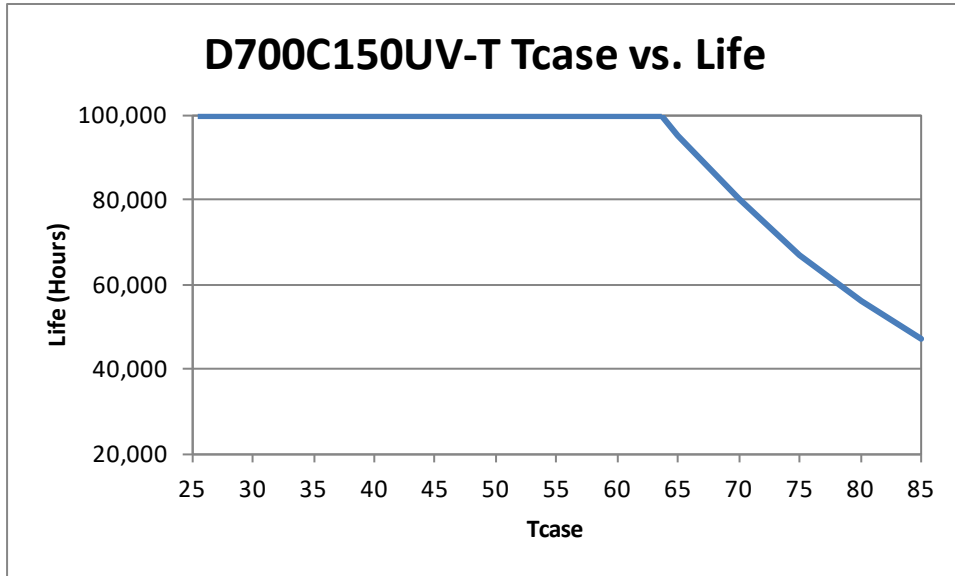

The Data curve provided predicts the LED Driver life based on the case temperature measured at the Tc location identified on the label or specification sheet. The Telecordia SR-332 standard is used to generate the prediction curves.

## Dimensional Diagram

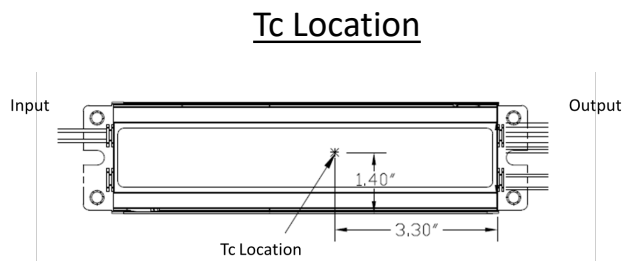
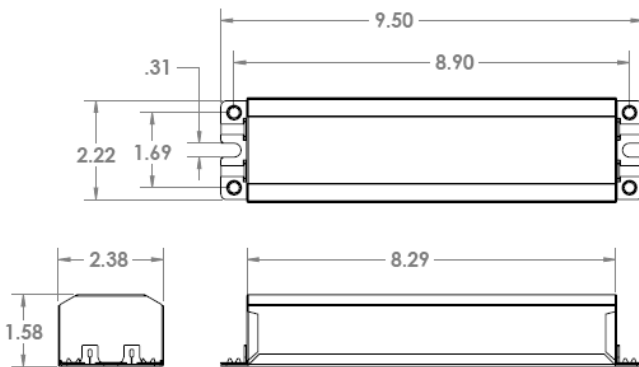

## Warranty:

Universal Lighting Technologies warrants to the purchaser that each power supply will be free from defects in material or workmanship for a period of 5 years from the date of manufacture when properly installed per instructions and under normal operating conditions of use. Call 1-800-225-5278 for technical assistance.

Application and operation performance specification information subject to change without notification.