

12 Volt 120 Watt Class 2 LED Driver

- Universal input voltage 120 – 277 Vac
- Damp and Dry Location Rated
- Two 60W Class 2 Output Channels



Performance

Input Voltage	120 ~ 277 Vac
Input Current Max	1.15A @ 120Vac 0.50 @ 277Vac
Input Power Max	140W
Input Frequency	50 - 60 (Hz)
Power Factor	> 0.90
THD Max	< 10%
Efficiency	> 86 % @ 120Vac > 88 % @ 277Vac
Output Voltage (per Channel)	12V
Output Current (per Channel)	5.0A
Output Power (per Channel)	60W
Line Regulation	±5 %
Load Regulation	±5 %
Output Voltage Ripple	< 1000mVp-p
Output Current Ripple	< 500mAp-p
Inrush Current	120V: 40A / 190uS
Peak / >50% Duration	277V: 76A / 205uS

Physical

Length	11.73 in (298.5 mm)
Width	1.70 in (43.2 mm)
Height	1.18 in (30.0 mm)
Mounting Length	11.14 in (283.0 mm)
Weight (lbs)	1.6
Lead Lengths	
Blk, Wht	12.5 in (317.5mm)
Red(+), Red/White(-)	12.5 in (317.5mm)
Blue(+), Blue/White(-)	18.5 in (469.9mm)

Environmental

EMI and RFI	Meets FCC part 15 (Class A) Non-Consumer Limits
Operating Temperature	-40°C to 55°C (-40°F to 131°F)
Storage Temperature	-40°C to 85°C (-40°F to 185°F)
tc	85°C max for warranty 90°C max for UL
Protection Rating	UL Dry & Damp
Transient Protection	IEEE C62.41 2.5kV

Wiring Diagram:

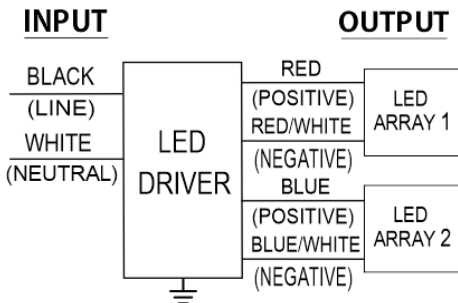

Protection

Over Voltage, Under Voltage, Short Circuit, Over Temp Safety:

UL 8750 & CSA 250.13-17
UL Class P



Ordering Information

Order Number	Description	Qty/Carton
L12V120UNV-S000I	12V 5.0A	1

Application and operation performance specification information subject to change without notification.

Performance: Efficiency

Typical performance measurements are shown. The charts are to be used as a guideline and not for specification use.

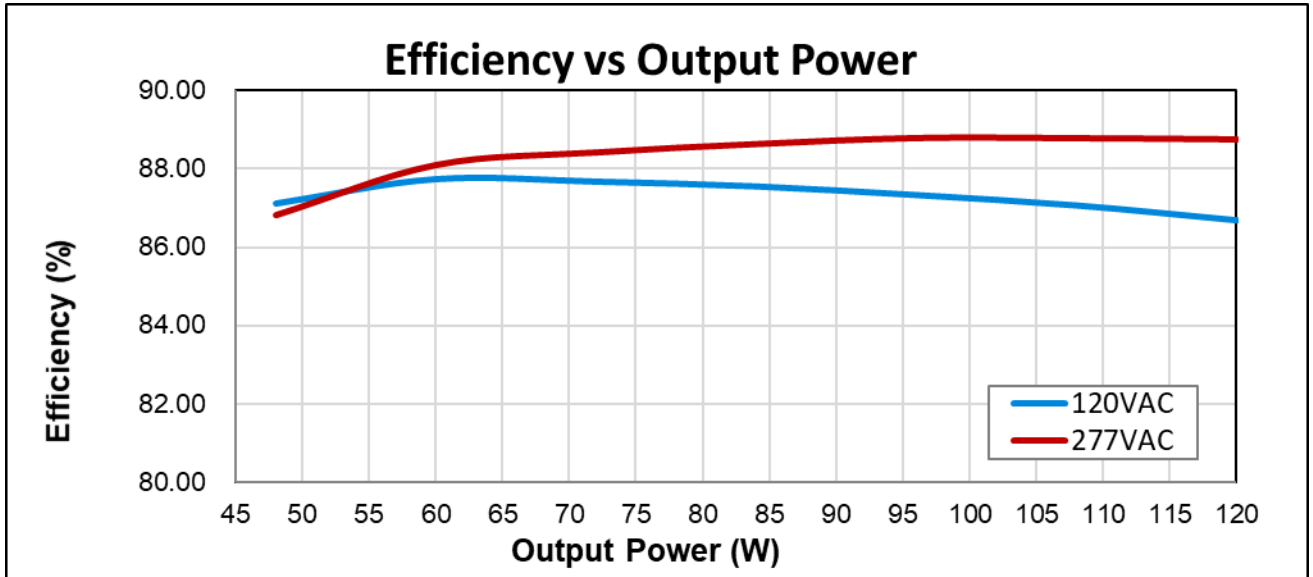

Application and operation performance specification information subject to change without notification.

Performance: Total Harmonic Distortion, & Power Factor

Typical performance measurements are shown. The charts are to be used as a guideline and not for specification use.

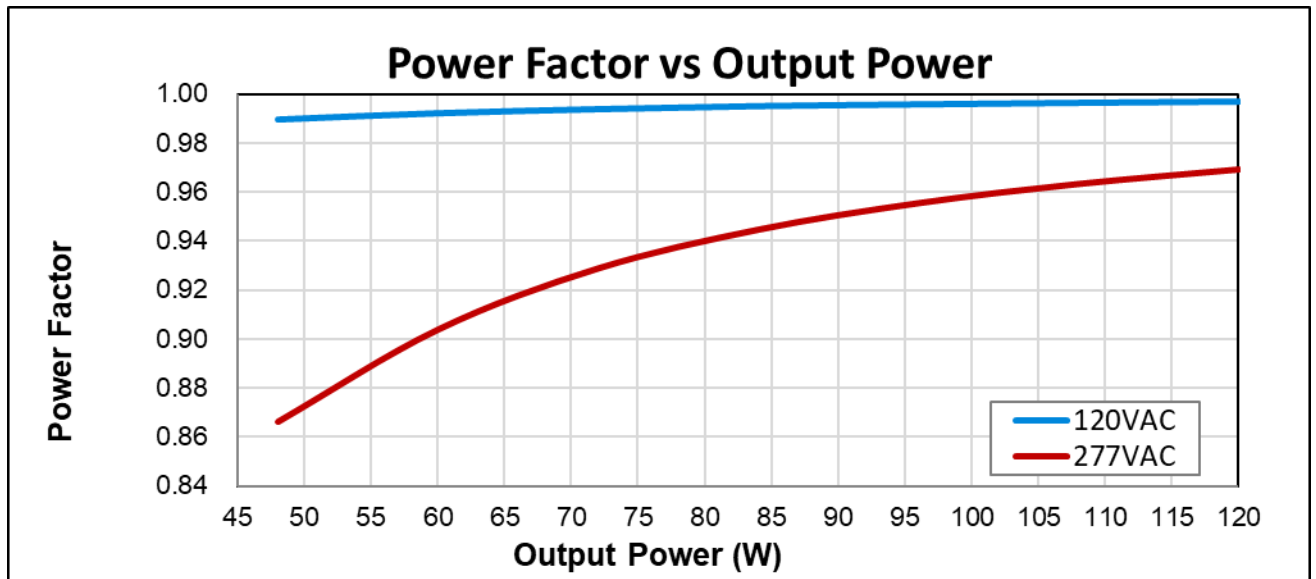
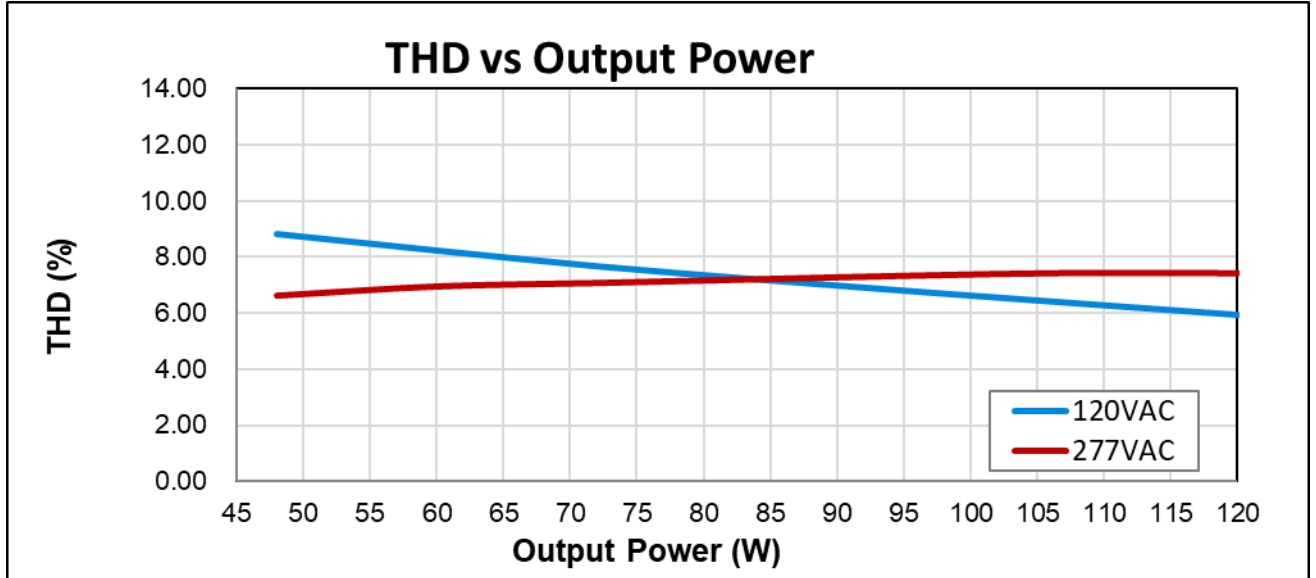

Output power based on maximum rated output current and varying load voltages.

Application and operation performance specification information subject to change without notification.

Transient Protection		
Transient	Differential Mode (L-N)	Common Mode (L-G, N-G, L&N-G)
IEEE C62.41 100kHz Ring Wave (200A maximum)	> 2.5kV	> 2.5kV

Isolation				
Isolation	Input	Output Channel 1	Output Channel 2	Enclosure
Input	-	2xU + 1kV	2xU + 1kV	2xU + 1kV
Output Channel 1	2xU + 1kV	-	-	500V
Output Channel 2	2xU + 1kV	-	-	500V
Enclosure	2xU + 1kV	500V	500V	-

U = Max Input Voltage

Driver Lifetime vs. Driver Case Temperature

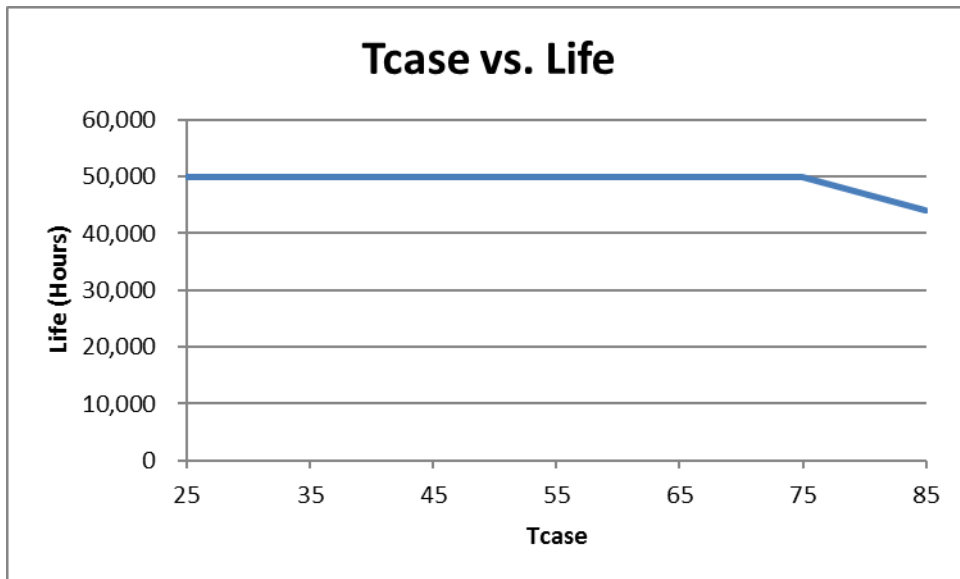

The Data curve provided predicts the LED Driver life based on the case temperature measured at the Tc location identified on the label or specification sheet. The Telecordia SR-332 standard is used to generate the prediction curves.

Application and operation performance specification information subject to change without notification.

Dimensional Diagram:

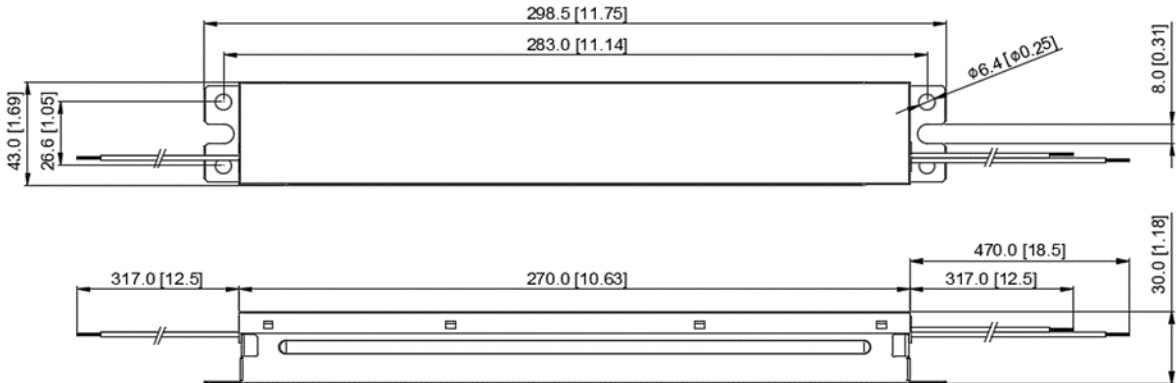

Tc Location:

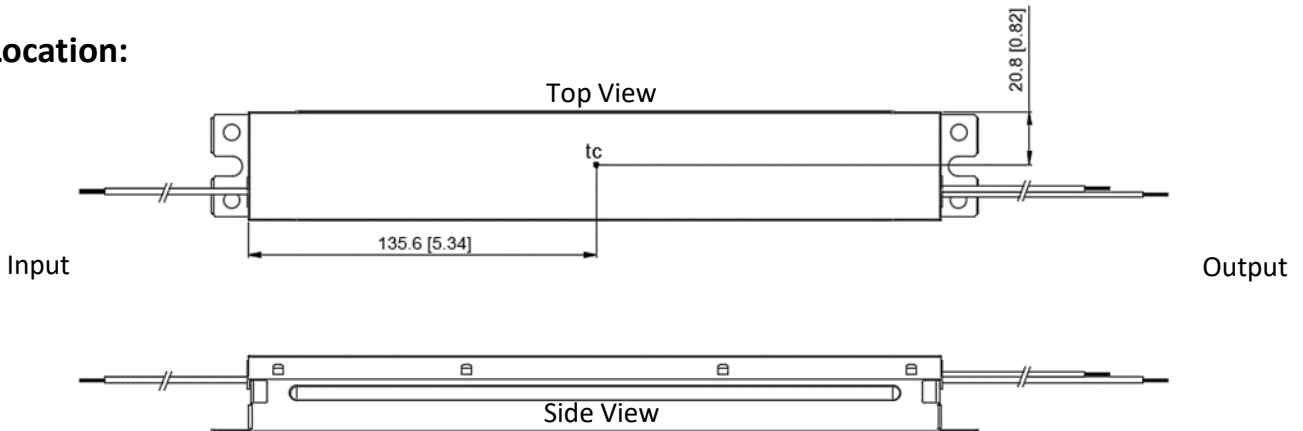

FCC Statement: This device complies with part 15 of the FCC Rules. Operation is subject to the following two conditions: (1) This device may not cause harmful interference, and (2) this device must accept any interference received, including interference that may cause undesired operation.

Warranty:

Universal Lighting Technologies warrants to the purchaser that each power supply will be free from defects in material or workmanship for a period of 5 years from the date of manufacture when properly installed per instructions and under normal operating conditions of use. Call 1-800-225-5278 for technical assistance.

Application and operation performance specification information subject to change without notification.