

## 24 Volt 96 Watt Class 2 LED Driver

- Universal input voltage 120 – 277 Vac
- Damp and Dry Location Rated
- 96W Class 2 Output



### Performance

Input Voltage	120 ~ 277 Vac
Input Current Max	0.95A @ 120Vac 0.40A @ 277Vac
Input Power Max	112W
Input Frequency	50 - 60 (Hz)
Power Factor	> 0.90 @ max load
THD Max	< 10% @ max load
Efficiency @ Full Load	> 87 % @ 120Vac > 88 % @ 277Vac
Output Voltage	24V
Output Current	4.0A
Output Power	96W
Load Regulation	±10 %
Output Voltage Ripple	< 1000mVp-p
Output Current Ripple	< 500mA p-p
Inrush Current	120V: 26A / 320uS
Peak / >50% Duration	277V: 61A / 300uS

### Wiring Diagram:

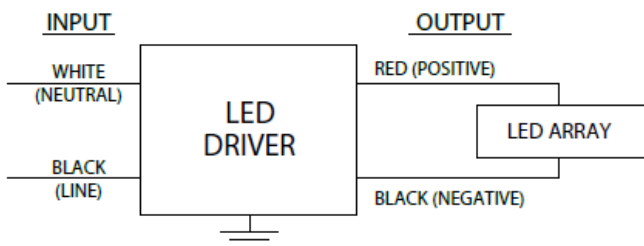

### Physical

Length	9.50 in (241.3 mm)
Width	1.71 in (43.4 mm)
Height	1.18 in (30.0 mm)
Mounting Length	8.90 in (226.1 mm)
Weight (lbs)	1.7
Lead Lengths	
Blk, Wht	12.5 in (317 mm)
Red(+), Black(-)	12.5 in (317 mm)

Lead-wires are 18 AWG 105°C / 600V solid copper.

### Environmental

EMI and RFI	Meets FCC part 15 (Class A) Non-Consumer Limits
Operating Temperature	-40°C to 50°C (-40°F to 122°F)
Storage Temperature	-40°C to 85°C (-40°F to 185°F)
tc	85°C max for warranty 85°C max for UL
Protection Rating	UL Dry & Damp
Transient Protection	IEEE C62.41 2.5kV

### Protection:

Over voltage, Overload and short circuit.

### Safety:

UL 8750 & CSA 250.13-17  
UL Class P



### Ordering Information

Order Number	Description	Qty/Carton
L24V100UNV-A000I	24V 4.0A	1
L24V100UNV-A000C	24V 4.0A	10

Application and operation performance specification information subject to change without notification.

## Performance: Efficiency

Typical performance measurements are shown. The charts are to be used as a guideline and not for specification use.

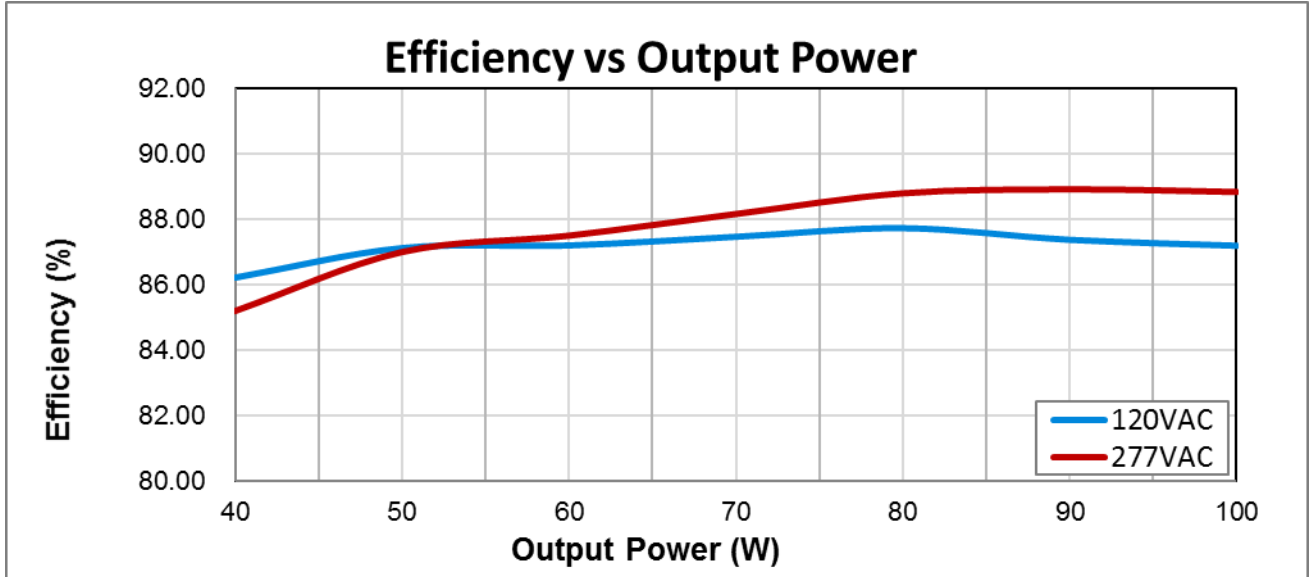

Application and operation performance specification information subject to change without notification.

## Performance: Total Harmonic Distortion, & Power Factor

Typical performance measurements are shown. The charts are to be used as a guideline and not for specification use.

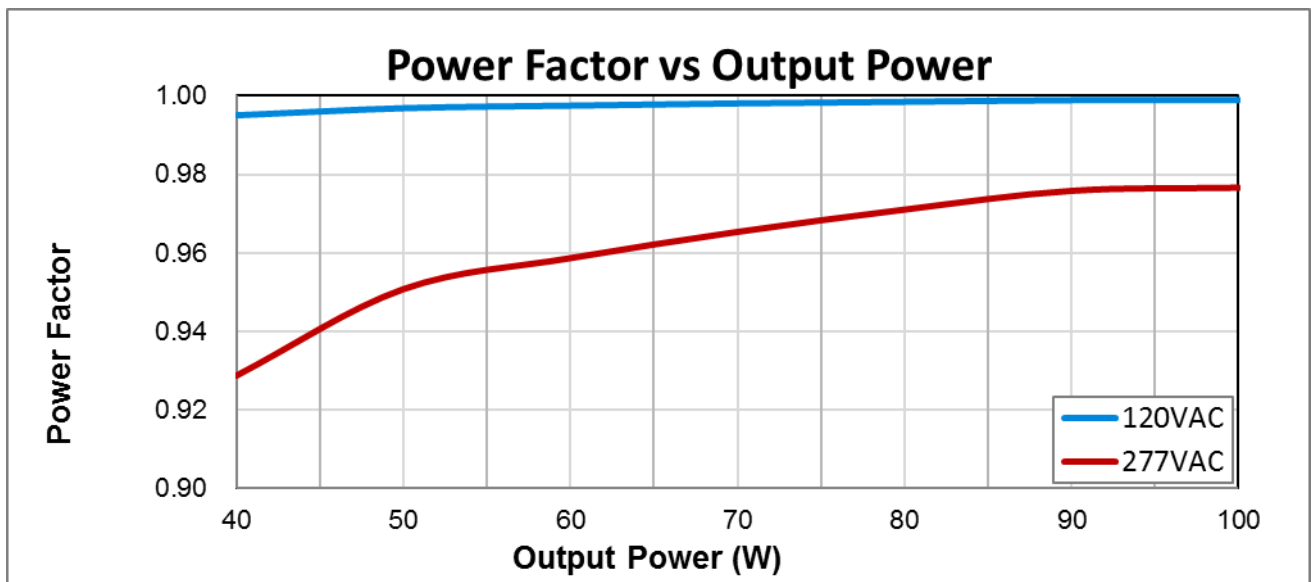
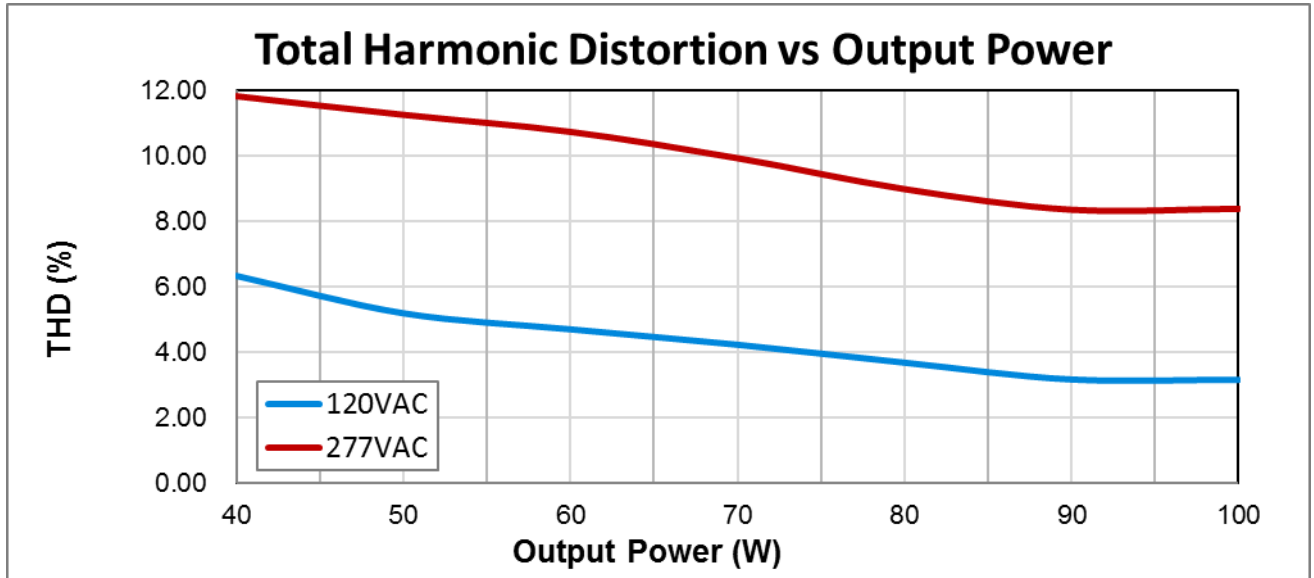

Output power based on maximum rated output current and varying load voltages.

Application and operation performance specification information subject to change without notification.

Transient Protection		
Transient	Differential Mode (L-N)	Common Mode (L-G, N-G, L&N-G)
IEEE C62.41 100kHz Ring Wave (200A maximum)	> 2.5kV	> 2.5kV

Isolation			
Isolation	Input	Output	Enclosure
Input	-	2xU + 1kV	2xU + 1kV
Output	2xU + 1kV	-	500V
Enclosure	2xU + 1kV	500V	-

U = Max Input Voltage

## Driver Lifetime vs. Driver Case Temperature

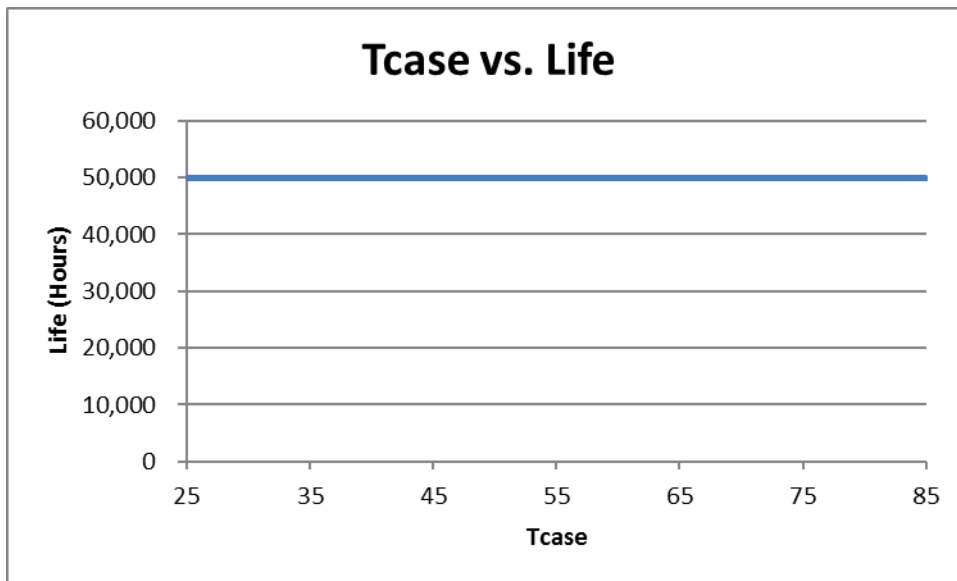

The Data curve provided predicts the LED Driver life based on the case temperature measured at the Tc location identified on the label or specification sheet. The Telecordia SR-332 standard is used to generate the prediction curves.

Application and operation performance specification information subject to change without notification.

## Dimensional Diagram:

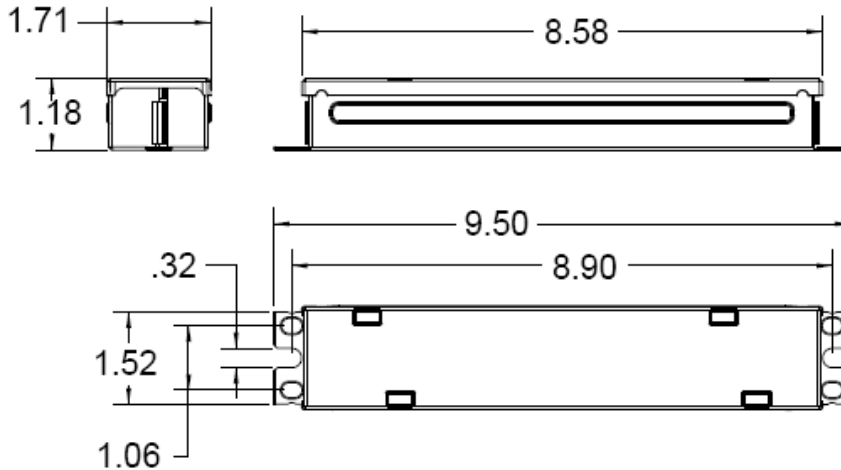

## Tc Location:

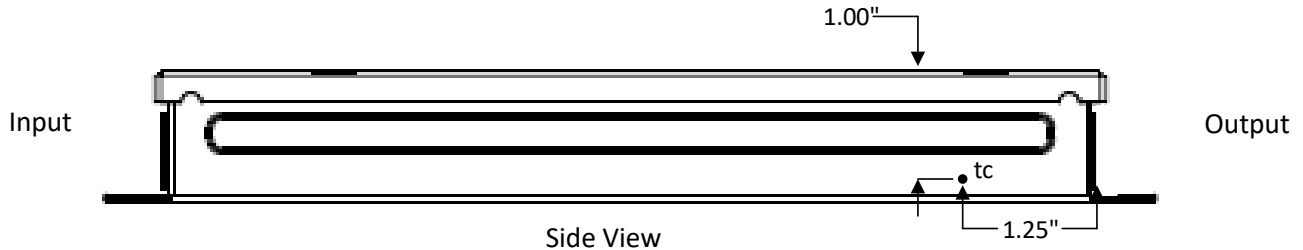

FCC Statement: This device complies with part 15 of the FCC Rules. Operation is subject to the following two conditions: (1) This device may not cause harmful interference, and (2) this device must accept any interference received, including interference that may cause undesired operation.

## Warranty:

Universal Lighting Technologies warrants to the purchaser that each power supply will be free from defects in material or workmanship for a period of 5 years from the date of manufacture when properly installed per instructions and under normal operating conditions of use. Call 1-800-225-5278 for technical assistance.

Application and operation performance specification information subject to change without notification.